



MKL ASANSÖR

HAYAL ETTİĞİNİZ HAYATA YÜKSELİN

ÜRÜN
KATALOGU
Product Catalogue



www.mklasansor.com



/mklasansor

Complete Elevator Solution



İçindekiler | Index

FİRMA PROFİLİ COMPANY PROFILE	4	RAY VE BAĞLANTI PARÇALARI ELEVATOR GUIDE RAILS FITTINGS	41
KALİTE POLİTİKAMIZ OUR QUALITY POLICY	5	SÜSPANSİYON & ŞASELER SUSPENSIONS & CHASIS	42
KABİNLER CABINS	6-21	ASANSÖR EKİPMANLARI ELEVATOR EQUIPMENT	43-45
TAVANLAR CEILINGS	22-23	KAYMA FRENLER PROGRESSIVE SAFETY GEARS	46
PASLANMAZLAR STAINLESS STEEL	24	REGÜLATÖRLER SPEED GOVERNORS	47
TABANLAR FLOORS	25	PANORAMİK ASANSÖR PANORAMIC ELEVATOR	48
LAMİNANTLAR LAMINATES	26	HASTA & YÜK ASANSÖRÜ HOSPITAL & GOODS ELEVATOR	49
HOLOGRAMLAR HOLOGRAMS	27	ARAÇ ASANSÖRÜ VEHICLE ELEVATOR	50
CAM KAPLAMALAR GLASS COATING	28-30	SERVİS ASANSÖRÜ DUMBWAITER	51
BUTONLAR BUTTONS	31-32	EV ASANSÖRÜ ENGELLİ PLATFORM HOME LIFTS & DISABLED LIFTS	52-53
MAKİNE MOTORLAR MACHINE MOTORS	33-34	ASANSÖR ÖLÇÜLERİ ELEVATOR DIMENSIONS	54-55
KUMANDA PANOLARI CONTROL PANELS	35-37	İŞ ORTAKLARIMIZ OUR BUSINESS PARTNERS	56
KAPILAR DOORS	38-40		

FİRMA PROFİLİ

2007 yılında Konya Sanayisinde kurulmuş iş dünyasında adını güven üzerine duyurmuş Marif Kalkan Demir San. Ve Tic.Ltd.Şti. ve kalkan lazer firmalarının e ndinamik kolu olarak hizmet veren MKL Asansör Oto.İnş.Nak.San. ve Tic.Ltd.Şti. asansör malzemeleri üretimi, tedarigi ve ihracatı yapmaktadır.

Globalleşen ve tamamen yüksek yapılarla gelişen dünya ülkelerinde insan ve eşya taşınması için asansör olmazsa olmaz bir yer almıştır. Can ve mal güvenliği için asansör ve kabin üretiminin ileri teknolojiye dayanarak üst düzey kalite standartlarına uygun bir şekilde yapılması büyük önem taşımaktadır.

MKL Asansör çağımızın en son teknolojilerini kullanarak sektörde gerçekleştiren tüm gelişmeleri takip etmektedir. İş ortakları ve referansları ile sabitlenmiş olan güvenilirliği, satış öncesi ve satış sonrası hizmetleri ile müşteri memnuniyetini ön planda tutmaktadır. Bir çok asansör firmasından farklı olarak üretiminin yanında lazer ve metal bölümündeki çözüm ortakları ile takas usulüne girerek bir çok ürün tedarigi sağlayan MKL Asansör, ürün yelpazesini genişletip müşterilerine daha uygun malzeme sağlayarak iş dünyasına farklı bir soluk getirmiştir.

Çalışan kadro ve üretim kalitesini hep birlikte değerlendiren MKL Asansör, profesyonel pazarlama ağı ile Konya'da sınırlı kalmamış, Türkiye'nin her iline ulaşmış, dış ticarete de atılarak uluslararası kurumsallaşan, şirketleşen bir firma haline gelmiştir. Firmamız tam kalite güvence sisteminde sahip olup konusunda uzman çalışanlarımızla projelerinize değer katacak en uygun çözüm ortağınızdır.

MKL Asansör, siz değerli müşterilerimize hizmet etmekten büyük mutluluk duymaktadır.

COMPANY PROFILE

Founded in 2007 in Konya Industry, Marif Kalkan Demir San. Ve Tic.Ltd.Şti. and Kalkan laser companies as the dynamic arm of MKL Asansör Oto.İnş.Nak.San. ve Tic.Ltd.Şti. produces, supplies and exports elevator materials.

Elevator has taken an indispensable place for the transportation of people and goods in the countries of the world, which are globalized and developed with completely high buildings. For the safety of life and property, it is of great importance that the elevator and cabin production is made in accordance with high quality standards by using advanced technology.

MKL Elevator follows all the developments in the sector by using the latest technologies of our age. It prioritizes customer satisfaction with its reliability, pre-sales and after-sales services, which are fixed by its business partners and references. Unlike many elevator companies, MKL Elevator, which provides a lot of products by entering the barter procedure with its solution partners in the laser and metal department in addition to its production, has expanded its product range and brought a different breath to the business world by providing more suitable materials to its customers.

Evaluating the quality of the production team working together MKL Elevator, not limited to professional marketing network in Konya, Turkey, has reached every province, was discharged to the institutionalization of international trade, it has become a corporate firm. Our company has a full quality assurance system and is your most suitable solution partner that will add value to your projects with our expert staff.

MKL Asansör is very happy to serve our valued customers.

PRODUCTION

We as MKL Elevator team: in order to improve speed, quality, reliability, technological, infrastructure of the production. We acquire more innovative modern product, which includes state of the art modern machines.

SALES

MKL Elevator is selling around more than 500 elevators in local market which is mostly installed by our team and third party contracts and for the international market we have a sales of more than 1000 elevators per years currently more than 85 countries around the globe and our main mission for the sales is to make a difference from other competitors by quality and competitive prices.

MODERNIZATION

Over time, such components of the elevators wear out and cause malfunctions. Modernization doesn't only bring you aesthetic innovation, this process also provides new safety standards. As MKL Elevator, we offer you to find correct point to solve with best solution.

VİZYONUMUZ

Asansör sektöründeki tüm gelişmeleri yakından takip edip, gelişmeleri kendi teknolojik sistemimize uyarlayarak, sürekli gelişme prensibi ile daima en iyiyi, en güvenli olanı ve kalite standartlarına göre bir çok ürün yelpazesini müşterilerin hizmetine sunmak...

OUR VISION

To follow all the developments in the elevator sector closely and adapt the developments to our own technological system, with the principle of continuous improvement, to always offer the best, the safest and many product ranges according to the quality standards to the service of the customers ...

MİSYONUMUZ

-Tüm projelerimizde insan güvenliğine önem veren kalite standartlarının zirvesinde müşterilerin ve çalışanların memnuniyetini artırma çabasında olmak,

-ISO 9001 :2000, CE gibi kalite yönetim sistemi şartlarına uymak,

-Zamanında ve hatasız üretim anlayışını benimsemek,

-Eğitim ile çalışanlarımızın yetkinliğini arttırmak,

OUR MISSION

-To strive to increase the satisfaction of customers and employees at the top of quality standards that attach importance to human safety in all our projects,

-To comply with the quality management system requirements such as ISO 9001: 2000, CE,

-To adopt timely and faultless production understanding,

-Increasing the competence of our employees through training,

SERTİFİKALAR VE BELGELER - CERTIFICATES AND DOCUMENTS

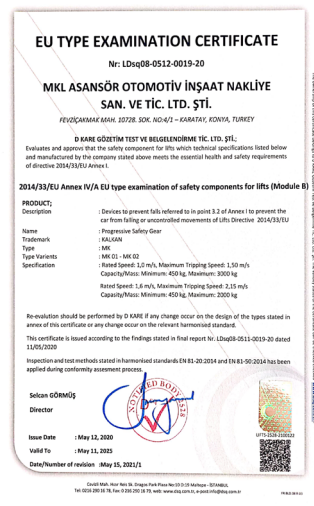
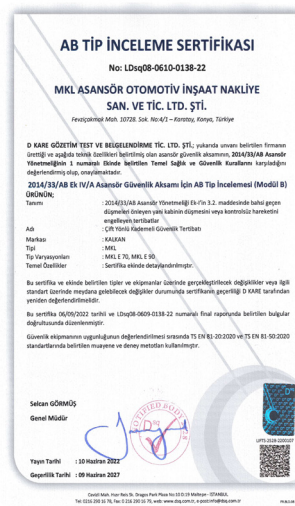
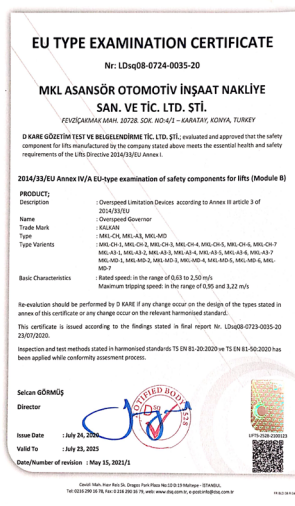

MKL-100



ÖZELLİKLER

- Paslanmaz Kabin :** 1,5mm galvanizli sac (304 kalite)
Laminant Kabin : 18 mm radüslü
Cam Görsel Kabin : Farklı renk ve desen uygulaması
Tavan : Komple lazer, cam ve led uygulaması
Taban : PVC anti-bakteriyel, 20mm. doğal granit ve farklı model ve malzeme seçenekleri
Ayna : Tam boy veya yarım boy seçenekleri.

PROPERTIES

- Stainless Steel Cabin :** 1,5mm galvanized sheet (304 quality)
Laminate Cabin : 18 mm with radius
Glass Cabin : Different colors and designs applications
Ceiling : Complete laser, glass and led applications
Floor : PVC anti-bacterial floor, 20mm. natural granite floor option and different base options.
Mirror : Full size or half size options.

"Ürün görselleri temsilidir. Spot lambaları ürüne dahil değildir."

"Product images are representative. Spot lamps are not included in the product."



MKL-101

*Hayal Ettiginiz
Hayata Yükselin
"Raise your imagine life"*

AÇIKLAMA

Tüm kabinlerde hazır aydınlatma, fan ve kayma fren özelliği mevcuttur.

Tavan, taban ve süspansiyonda statik boya yapılabilir.
Tercihe bağlı olarak sandık ambalaj mevcuttur.

DESCRIPTION

Ready to run lighting and fan. Floor, ceiling, suspensions static paint.

Optional case packing. Progressive safety gear is a standard in all of our cabins.

MKL-102



MKL-103



ÖZELLİKLER

- Paslanmaz Kabin :** 1,5mm galvanizli sac (304 kalite)
Laminant Kabin : 18 mm radüslü
Cam Görsel Kabin: Farklı renk ve desen uygulaması
Tavan : Komple lazer, cam ve led uygulaması
Taban : PVC anti-bakteriyel, 20mm. doğal granit ve farklı model ve malzeme seçenekleri
Ayna : Tam boy veya yarım boy seçenekleri.

PROPERTIES

- Stainless Steel Cabin:** 1,5mm galvanized sheet (304 quality)
Laminate Cabin : 18 mm with radius
Glass Cabin : Different colors and designs applications
Ceiling : Complete laser, glass and led applications
Floor : PVC anti-bacterial floor, 20mm. natural granite floor option and different base options.
Mirror : Full size or half size options.

"Ürün görselleri temsilidir. Spot lambaları ürüne dahil değildir."

"Product images are representative. Spot lamps are not included in the product."

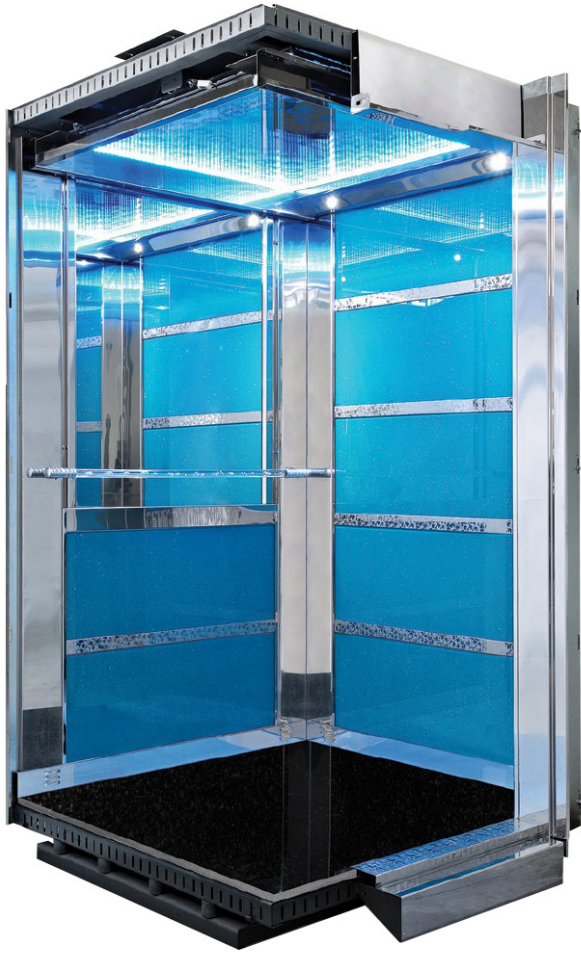

MKL-104

*Hayal Ettiginiz
Hayata Yükselin
"Raise your imagine life"*

AÇIKLAMA

Tüm kabinlerde hazır aydınlatma, fan ve kayma fren özelliği mevcuttur.

Tavan, taban ve süspansiyonda statik boya yapılabilir.
Tercihe bağlı olarak sandık ambalaj mevcuttur.

DESCRIPTION

Ready to run lighting and fan. Floor, ceiling, suspensions static paint.

Optional case packing. Progressive safety gear is a standard in all of our cabins.

MKL-105



MKL-106



ÖZELLİKLER

- Paslanmaz Kabin :** 1,5mm galvanizli sac (304 kalite)
Laminant Kabin : 18 mm radüslü
Cam Görsel Kabin : Farklı renk ve desen uygulaması
Tavan : Komple lazer, cam ve led uygulaması
Taban : PVC anti-bakteriyel, 20mm. doğal granit ve farklı model ve malzeme seçenekleri
Ayna : Tam boy veya yarım boy seçenekleri.

"Ürün görselleri temsilidir. Spot lambaları ürüne dahil değildir."

PROPERTIES

- Stainless Steel Cabin :** 1,5mm galvanized sheet (304 quality)
Laminate Cabin : 18 mm with radius
Glass Cabin : Different colors and designs applications
Ceiling : Complete laser, glass and led applications
Floor : PVC anti-bacterial floor, 20mm. natural granite floor option and different base options.
Mirror : Full size or half size options.

"Product images are representative. Spot lamps are not included in the product."



MKL-107

*Hayal Ettiginiz
Hayata Yükselin
"Raise your imagine life"*

AÇIKLAMA

Tüm kabinlerde hazır aydınlatma, fan ve kayma fren özelliği mevcuttur.
Tavan, taban ve süspansiyonda statik boya yapılabilir.
Tercihe bağlı olarak sandık ambalaj mevcuttur.

DESCRIPTION

Ready to run lighting and fan. Floor, ceiling, suspensions static paint.
Optional case packing. Progressive safety gear is a standard in all of our cabins.

MKL-108

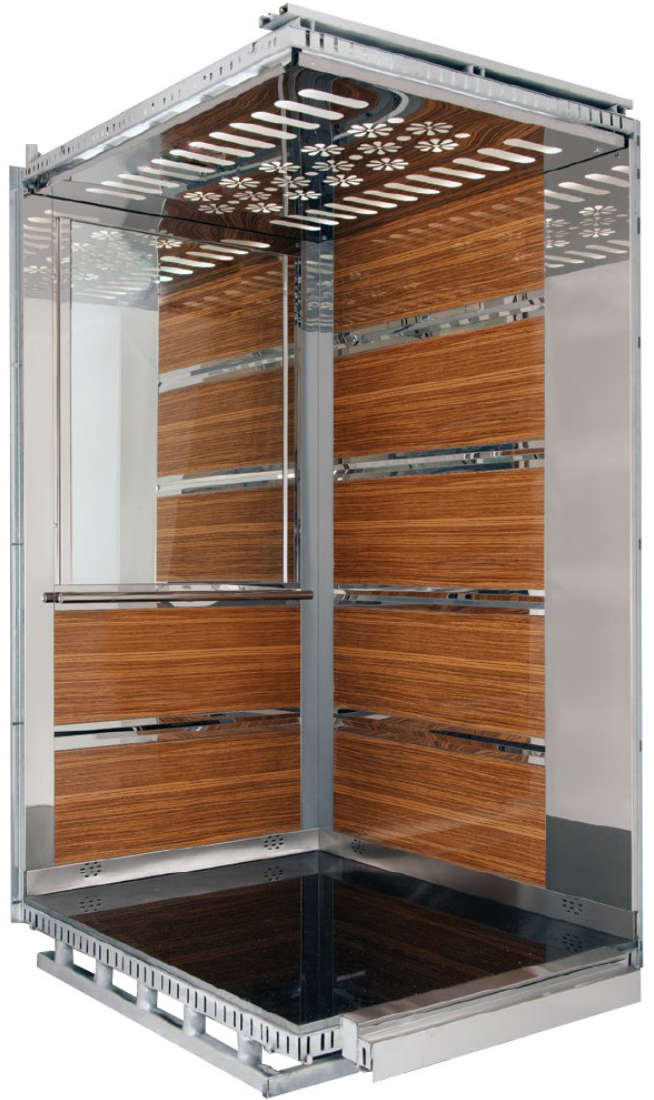

MKL-109



ÖZELLİKLER

- Paslanmaz Kabin :** 1,5mm galvanizli sac (304 kalite)
Laminant Kabin : 18 mm radüslü
Cam Görsel Kabin: Farklı renk ve desen uygulaması
Tavan : Komple lazer, cam ve led uygulaması
Taban : PVC anti-bakteriyel, 20mm. doğal granit ve farklı model ve malzeme seçenekleri
Ayna : Tam boy veya yarım boy seçenekleri.

"Ürün görselleri temsilidir. Spot lambaları ürüne dahil değildir."

PROPERTIES

- Stainless Steel Cabin:** 1,5mm galvanized sheet (304 quality)
Laminate Cabin : 18 mm with radius
Glass Cabin : Different colors and designs applications
Ceiling : Complete laser, glass and led applications
Floor : PVC anti-bacterial floor, 20mm. natural granite floor option and different base options.
Mirror : Full size or half size options.

"Product images are representative. Spot lamps are not included in the product."



MKL-110

MKL STANDART KABİN - MKL STANDARD CABIN

AÇIKLAMA

Tüm kabinlerde hazır aydınlatma, fan ve kayma fren özelliği mevcuttur.

Tavan, taban ve süspansiyonda statik boya yapılabilir.
Tercihe bağlı olarak sandık ambalaj mevcuttur.

DESCRIPTION

Ready to run lighting and fan. Floor, ceiling, suspensions static paint.

Optional case packing. Progressive safety gear is a standard in all of our cabins.

MKL-111



MKL-112



ÖZELLİKLER

- Paslanmaz Kabin :** 1,5mm galvanizli sac (304 kalite)
Laminant Kabin : 18 mm radüslü
Cam Görsel Kabin: Farklı renk ve desen uygulaması
Tavan : Komple lazer, cam ve led uygulaması
Taban : PVC anti-bakteriyel, 20mm. doğal granit ve farklı model ve malzeme seçenekleri
Ayna : Tam boy veya yarım boy seçenekleri.

"Ürün görselleri temsilidir. Spot lambaları ürüne dahil değildir."

PROPERTIES

- Stainless Steel Cabin:** 1,5mm galvanized sheet (304 quality)
Laminate Cabin : 18 mm with radius
Glass Cabin : Different colors and designs applications
Ceiling : Complete laser, glass and led applications
Floor : PVC anti-bacterial floor, 20mm. natural granite floor option and different base options.
Mirror : Full size or half size options.

"Product images are representative. Spot lamps are not included in the product."



MKL-113

*Hayal Ettiginiz
Hayata Yükselin
"Raise your imagine life"*

AÇIKLAMA

Tüm kabinlerde hazır aydınlatma, fan ve kayma fren özelliği mevcuttur.

Tavan, taban ve süspansiyonda statik boya yapılabilir.
Tercihe bağlı olarak sandık ambalaj mevcuttur.

DESCRIPTION

Ready to run lighting and fan. Floor, ceiling, suspensions static paint.

Optional case packing. Progressive safety gear is a standard in all of our cabins.

MKL-114



MKL-115



ÖZELLİKLER

- Paslanmaz Kabin :** 1,5mm galvanizli sac (304 kalite)
Laminant Kabin : 18 mm radüslü
Cam Görsel Kabin: Farklı renk ve desen uygulaması
Tavan : Komple lazer, cam ve led uygulaması
Taban : PVC anti-bakteriyel, 20mm. doğal granit ve farklı model ve malzeme seçenekleri
Ayna : Tam boy veya yarım boy seçenekleri.

"Ürün görselleri temsilidir. Spot lambaları ürüne dahil değildir."

PROPERTIES

- Stainless Steel Cabin:** 1,5mm galvanized sheet (304 quality)
Laminate Cabin : 18 mm with radius
Glass Cabin : Different colors and designs applications
Ceiling : Complete laser, glass and led applications
Floor : PVC anti-bacterial floor, 20mm. natural granite floor option and different base options.
Mirror : Full size or half size options.

"Product images are representative. Spot lamps are not included in the product."



MKL-116

*Hayal Ettiginiz
Hayata Yükselin
"Raise your imagine life"*

AÇIKLAMA

Tüm kabinlerde hazır aydınlatma, fan ve kayma fren özelliği mevcuttur.

Tavan, taban ve süspansiyonda statik boya yapılabilir.
Tercihe bağlı olarak sandık ambalaj mevcuttur.

DESCRIPTION

Ready to run lighting and fan. Floor, ceiling, suspensions static paint.

Optional case packing. Progressive safety gear is a standard in all of our cabins.

MKL-117



MKL-118



ÖZELLİKLER

- Paslanmaz Kabin :** 1,5mm galvanizli sac (304 kalite)
Laminant Kabin : 18 mm radüslü
Cam Görsel Kabin: Farklı renk ve desen uygulaması
Tavan : Komple lazer, cam ve led uygulaması
Taban : PVC anti-bakteriyel, 20mm. doğal granit ve farklı model ve malzeme seçenekleri
Ayna : Tam boy veya yarım boy seçenekleri.

"Ürün görselleri temsilidir. Spot lambaları ürüne dahil değildir."

PROPERTIES

- Stainless Steel Cabin:** 1,5mm galvanized sheet (304 quality)
Laminate Cabin : 18 mm with radius
Glass Cabin : Different colors and designs applications
Ceiling : Complete laser, glass and led applications
Floor : PVC anti-bacterial floor, 20mm. natural granite floor option and different base options.
Mirror : Full size or half size options.

"Product images are representative. Spot lamps are not included in the product."

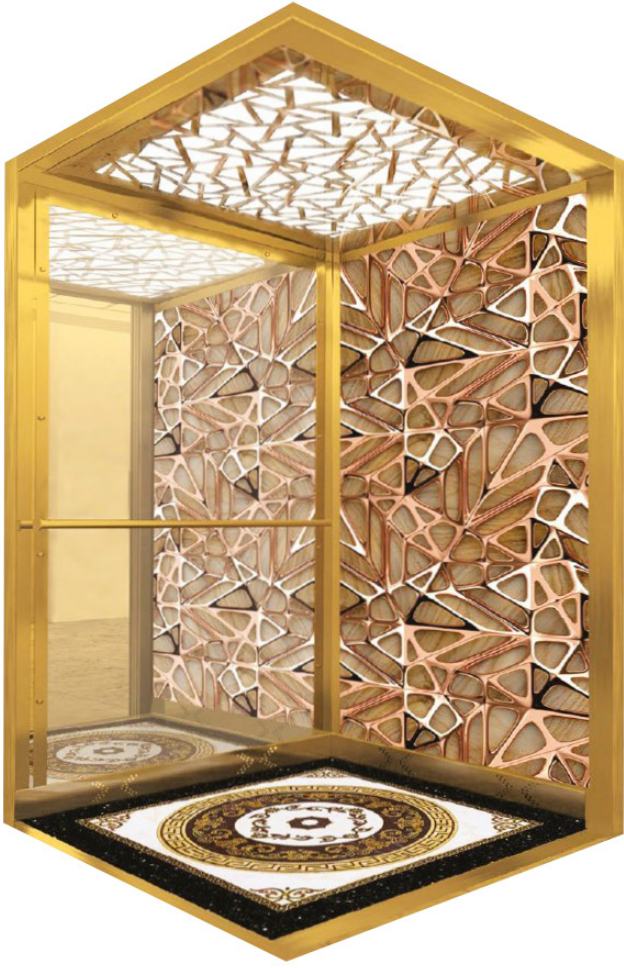

MKL-119

*Hayal Ettiginiz
Hayata Yükselin
"Raise your imagine life"*

AÇIKLAMA

Tüm kabinlerde hazır aydınlatma, fan ve kayma fren özelliği mevcuttur.

Tavan, taban ve süspansiyonda statik boya yapılabilir.
Tercihe bağlı olarak sandık ambalaj mevcuttur.

DESCRIPTION

Ready to run lighting and fan. Floor, ceiling, suspensions static paint.

Optional case packing. Progressive safety gear is a standard in all of our cabins.

MKL-120



MKL-121



ÖZELLİKLER

- Paslanmaz Kabin :** 1,5mm galvanizli sac (304 kalite)
Laminant Kabin : 18 mm radüslü
Cam Görsel Kabin : Farklı renk ve desen uygulaması
Tavan : Komple lazer, cam ve led uygulaması
Taban : PVC anti-bakteriyel, 20mm. doğal granit ve farklı model ve malzeme seçenekleri
Ayna : Tam boy veya yarım boy seçenekleri.

"Ürün görselleri temsilidir. Spot lambaları ürüne dahil değildir."

PROPERTIES

- Stainless Steel Cabin :** 1,5mm galvanized sheet (304 quality)
Laminate Cabin : 18 mm with radius
Glass Cabin : Different colors and designs applications
Ceiling : Complete laser, glass and led applications
Floor : PVC anti-bacterial floor, 20mm. natural granite floor option and different base options.
Mirror : Full size or half size options.

"Product images are representative. Spot lamps are not included in the product."



MKL STANDART KABİN - MKL STANDARD CABIN

AÇIKLAMA

Tüm kabinlerde hazır aydınlatma, fan ve kayma fren özelliği mevcuttur.

Tavan, taban ve süspansiyonda statik boya yapılabilir.
Tercihe bağlı olarak sandık ambalaj mevcuttur.

DESCRIPTION

Ready to run lighting and fan. Floor, ceiling, suspensions static paint.

Optional case packing. Progressive safety gear is a standard in all of our cabins.

MKL-122

*Hayal Ettiğiniz
Hayata Yükselin
"Raise your imagine life"*



MKL-123

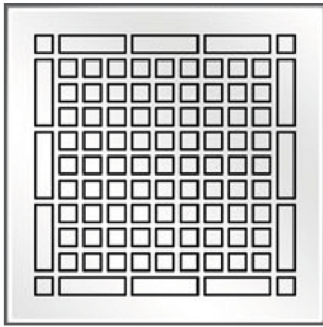

TVN 01

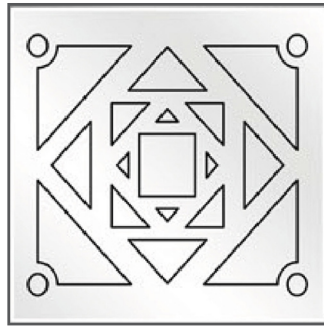

TVN 02

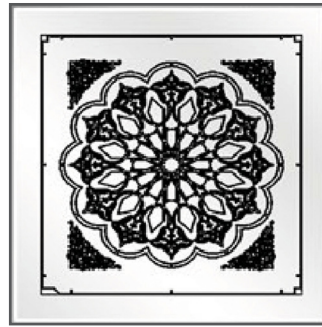

TVN 03



TVN 04

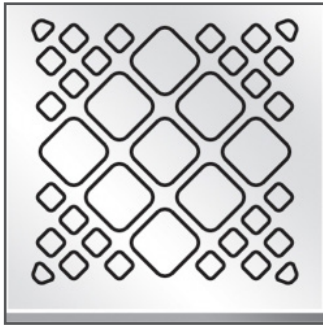

TVN 05

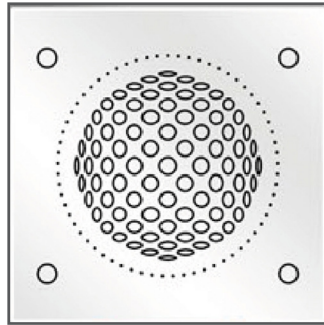

TVN 06

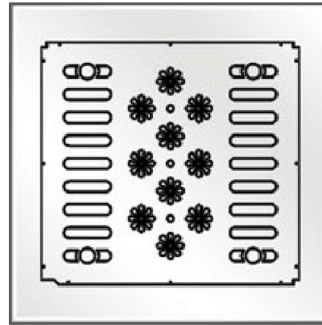

TVN 07



TVN 08

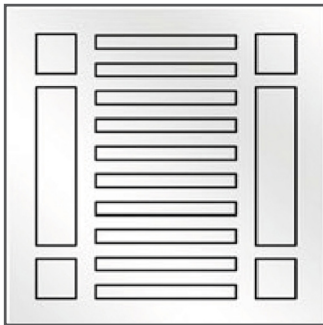

TVN 09

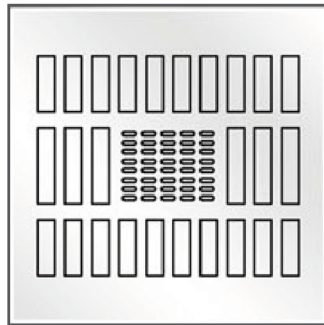

TVN 10

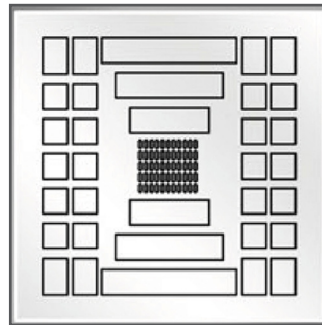

TVN 11

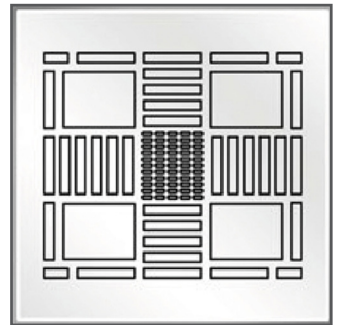

TVN 12

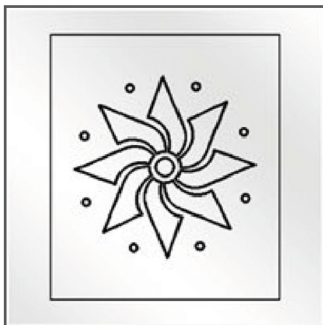

TVN 13

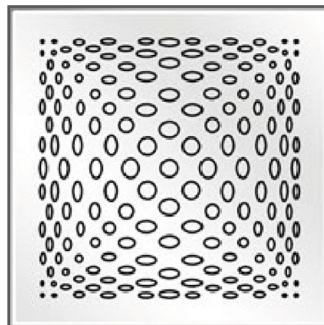

TVN 14

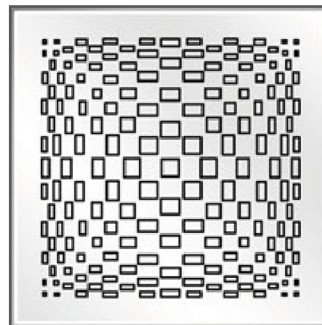

TVN 15



TVN 16



TVN 17

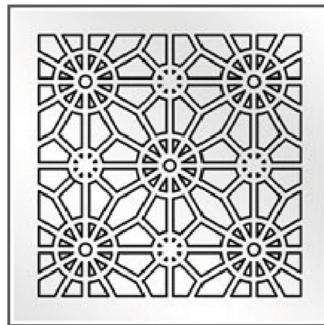

TVN 18

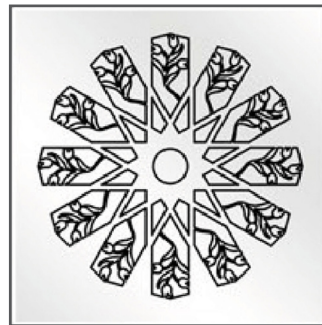

TVN 19

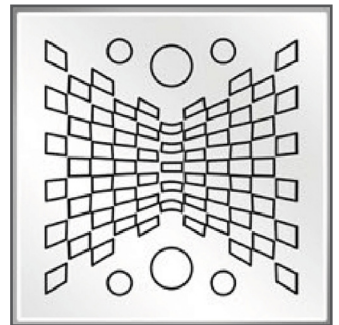

TVN 20

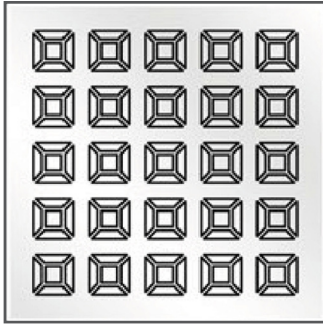

TVN 21



TVN 22

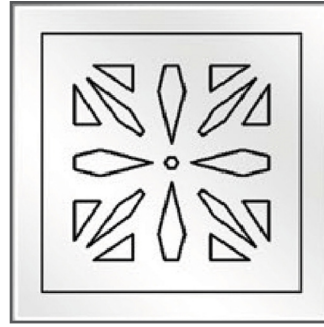

TVN 23



TVN 24

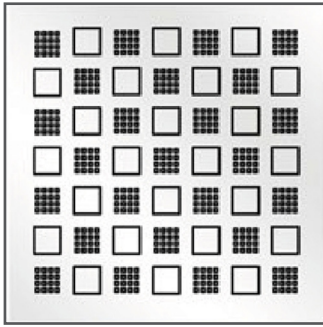

TVN 25



TVN 26

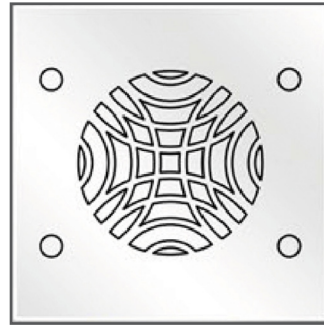

TVN 27



TVN 28



TVN 29

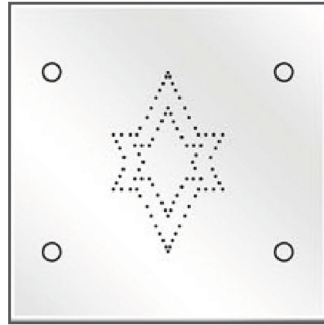

TVN 30

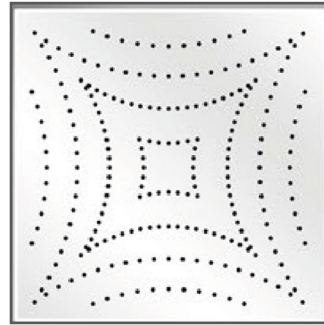

TVN 31

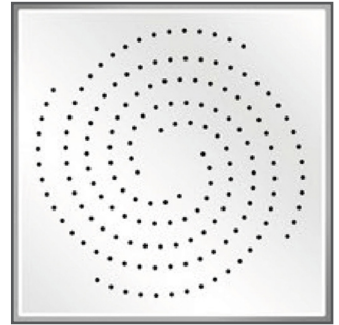

TVN 32



TVN 33

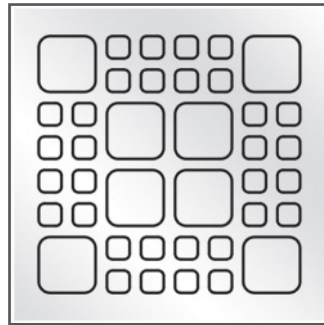

TVN 34

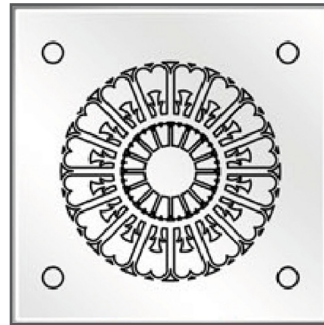

TVN 35



TVN 36

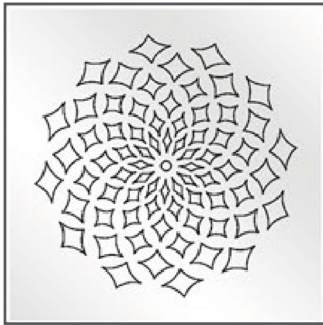

TVN 37

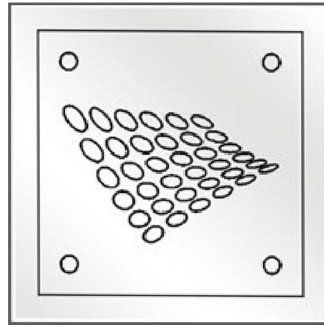

TVN 38



TVN 39

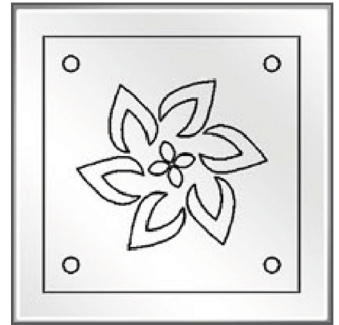

TVN 40



P-100



P-101



P-102



P-103



P-104



P-105



P-106



P-107

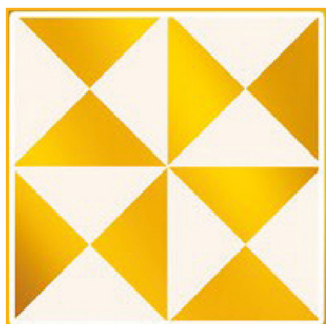

P-108



P-109



P-110



P-111



P-112



P-113



P-114



P-115



P-116



P-117

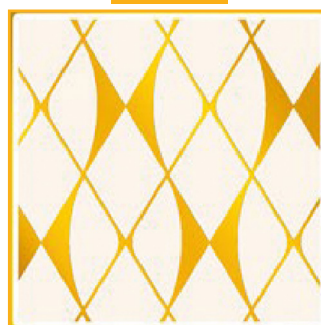

P-118

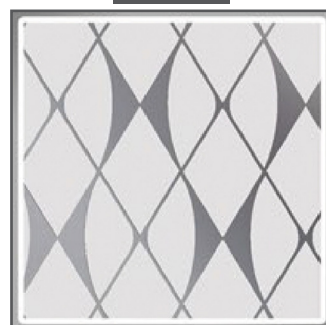

P-119

GRANİT VE PVC TABAN SEÇENEKLERİ - GRANITE AND PVC FLOOR OPTIONS

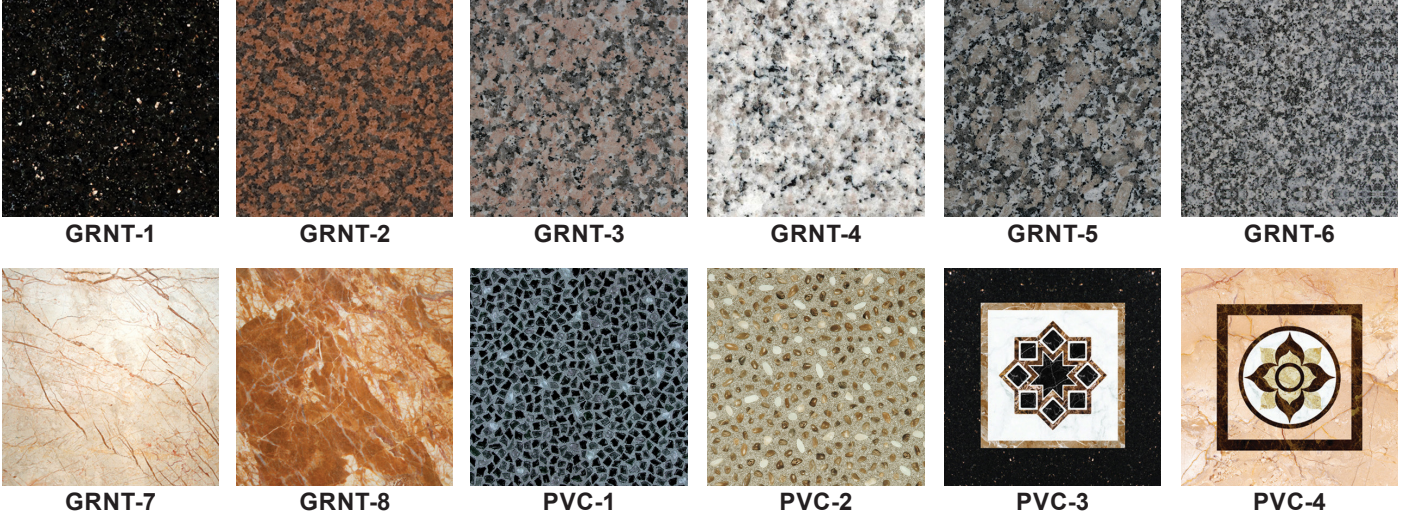

LAMİNE (TEMPERLİ) TABAN CAM SEÇENEKLERİ - LAMINE (TEMPERED) GLASS FLOOR OPTIONS

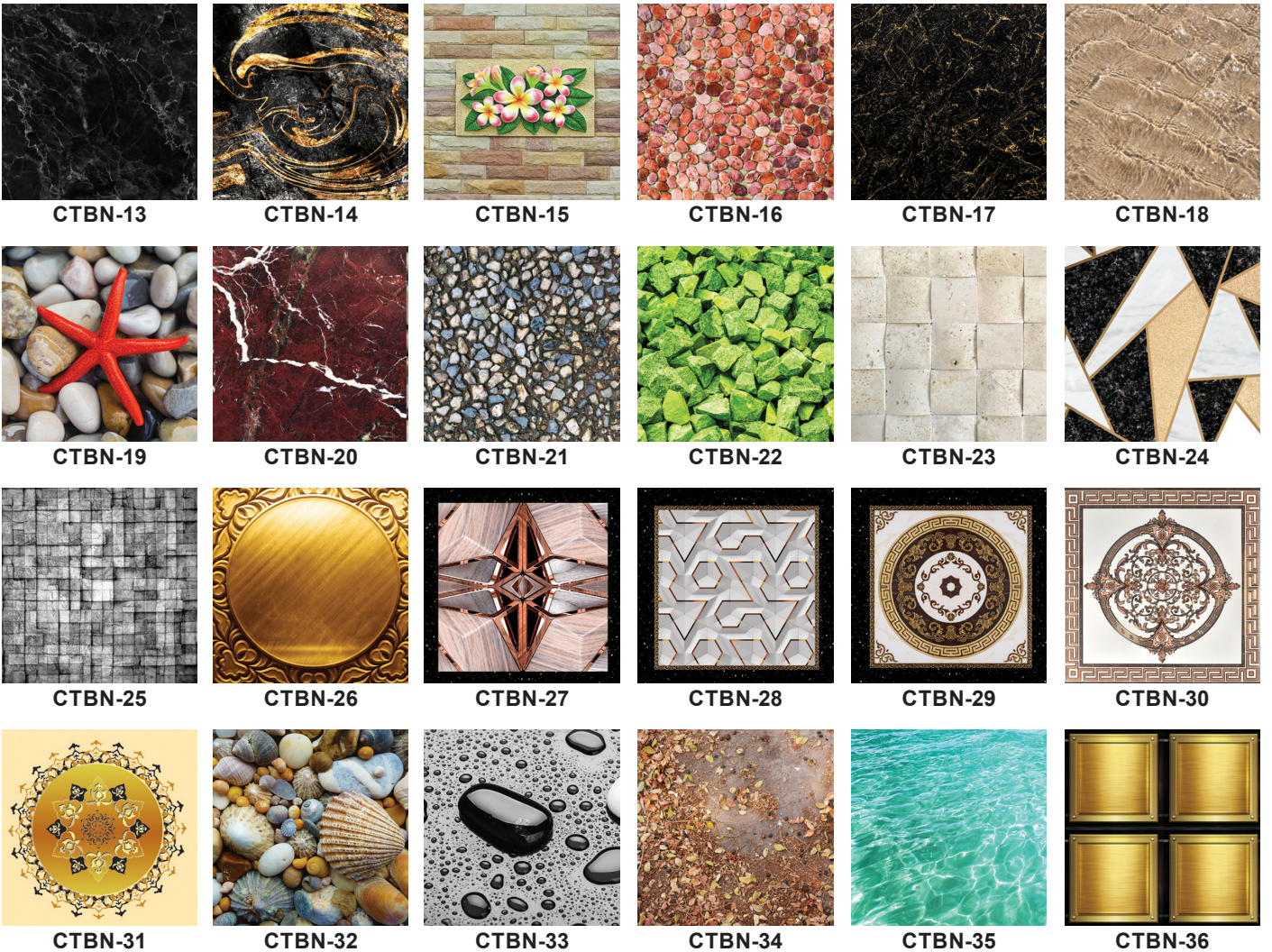



L-1



L-2



L-3



L-4



L-5



L-6



L-7



L-8



L-9



L-10



L-11



L-12



L-13



L-14



L-15



L-16



L-17



L-18



L-19



L-20



H-01

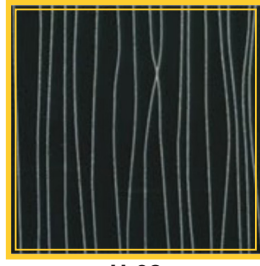

H-02

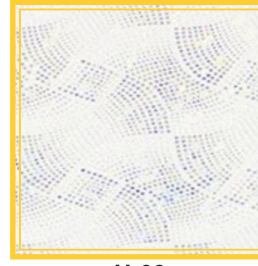

H-03

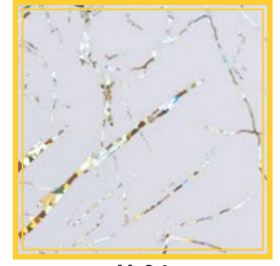

H-04



H-05



H-06

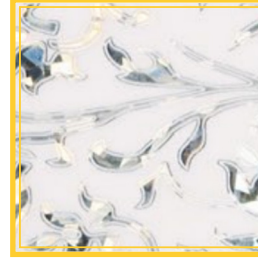

H-07



H-08



H-09

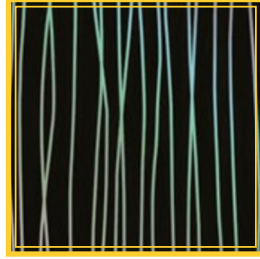

H-10



H-11

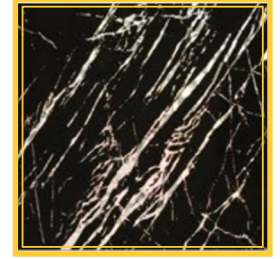

H-12



H-13



H-14



H-15



H-16



H-17



H-18



H-19



H-20

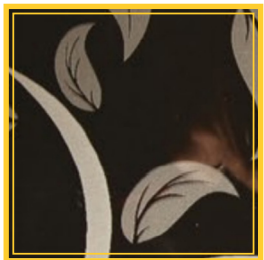

H-21



H-22

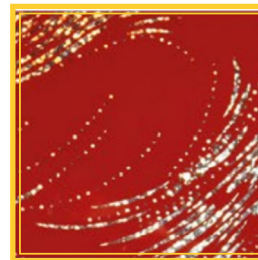

H-23



H-24



CM-01



CM-02



CM-03

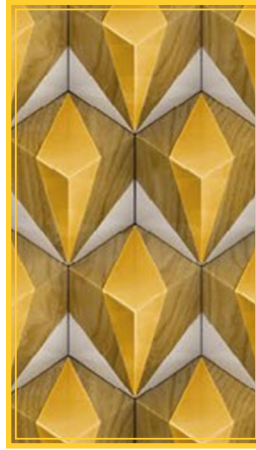

CM-04

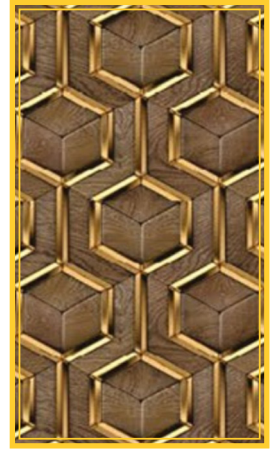

CM-05



CM-06



CM-07

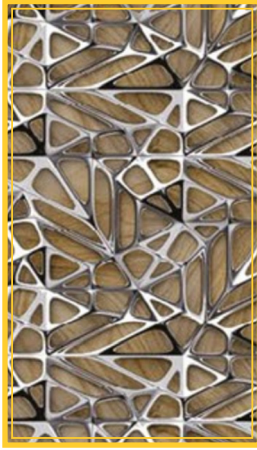

CM-08

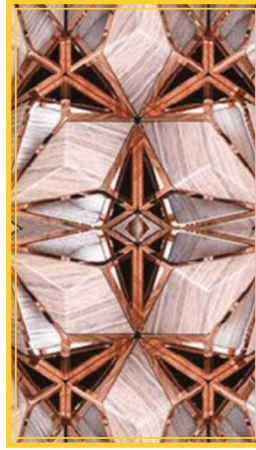

CM-09



CM-10



CM-11



CM-12



CM-13

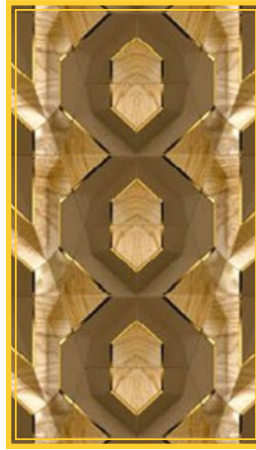

CM-14



CM-15



CM-16

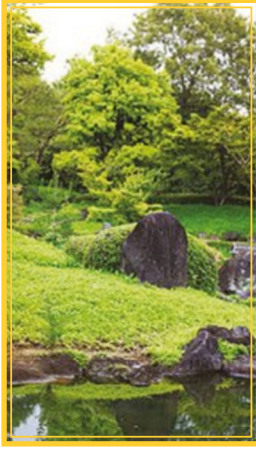

CM-17



CM-18



CM-19



CM-20



CM-21

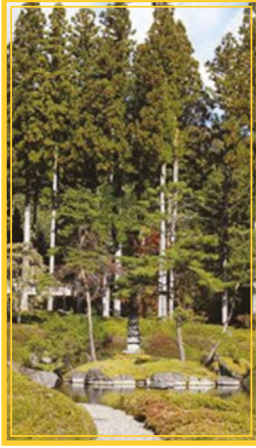

CM-22

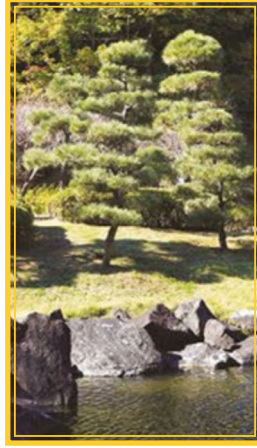

CM-23

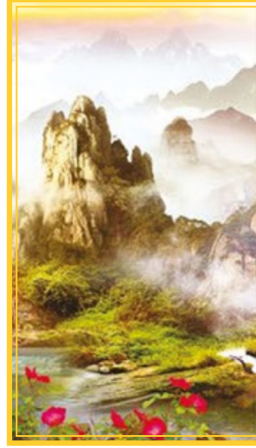

CM-24



CM-25



CM-26

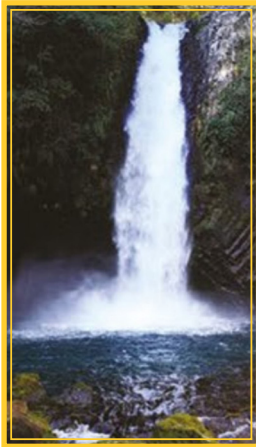

CM-27

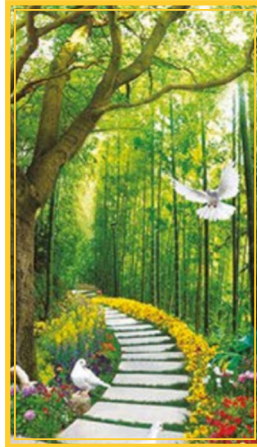

CM-28



CM-29



CM-30

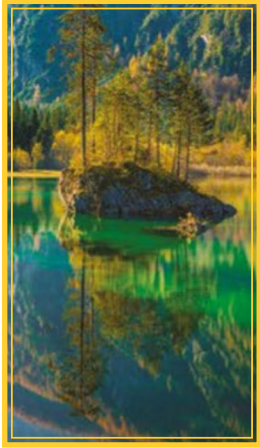

CM-31



CM-32



CM-33

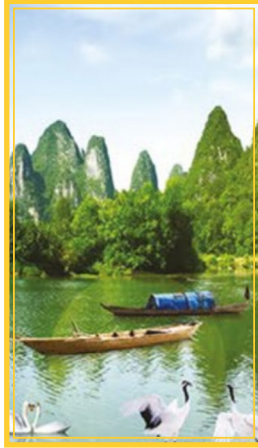

CM-34

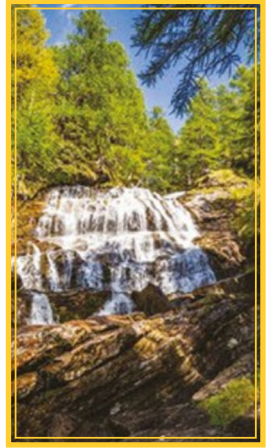

CM-35



CM-36



CM-37



CM-38

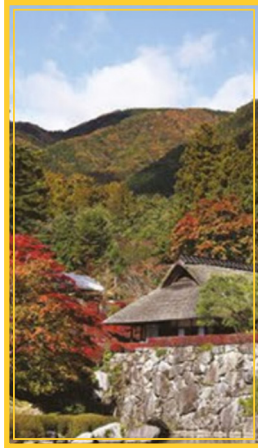

CM-39



CM-40

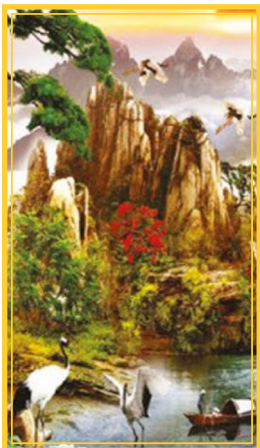

CM-41



CM-42



CM-43

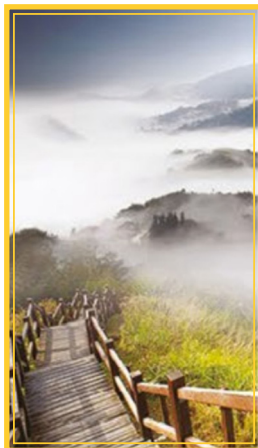

CM-44

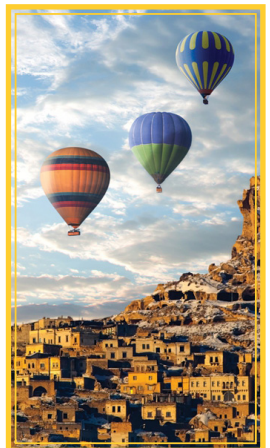

CM-45

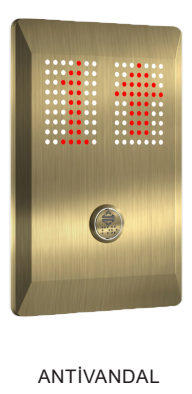

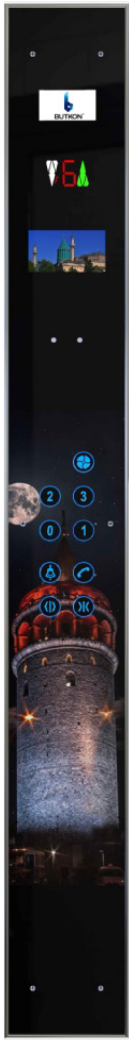

U31TM0001



U21TM0013



U21TM0001

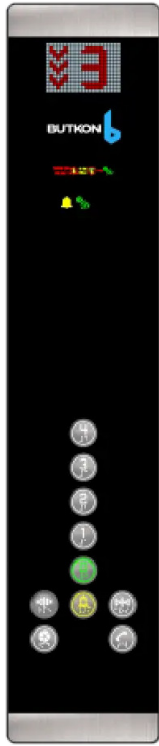

U21YR0012

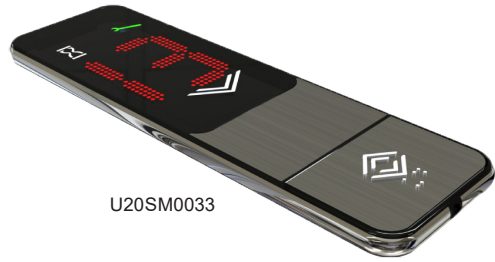

U20SM0033

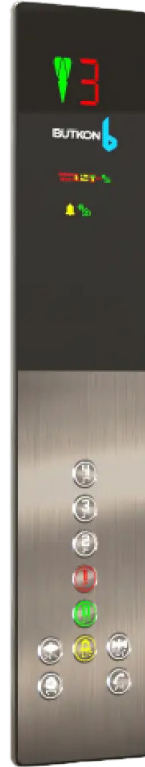

U21YR0015

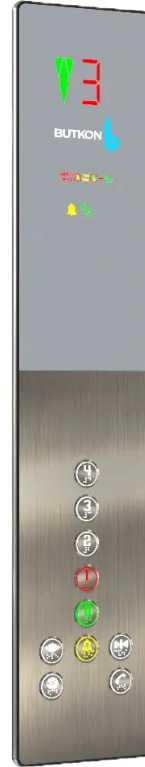

U21YR0016



U21YR0013



U20SM0010



U20SM0028



U20SM0001



U20SM0003



U20SM0001



U20YE0001



U20YE0002



U20YE0003



U20YE0004



U20YE0005



U20YE0006



U20YE0007



U28SM0002



U28SM0001



U30SM0002

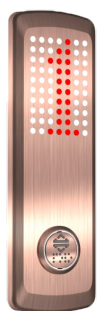

ANTI VANDAL



U26DJ0001



U26DJ0001



U26DJ0002



U26DJ0001



U26DB0002



U28DB0004

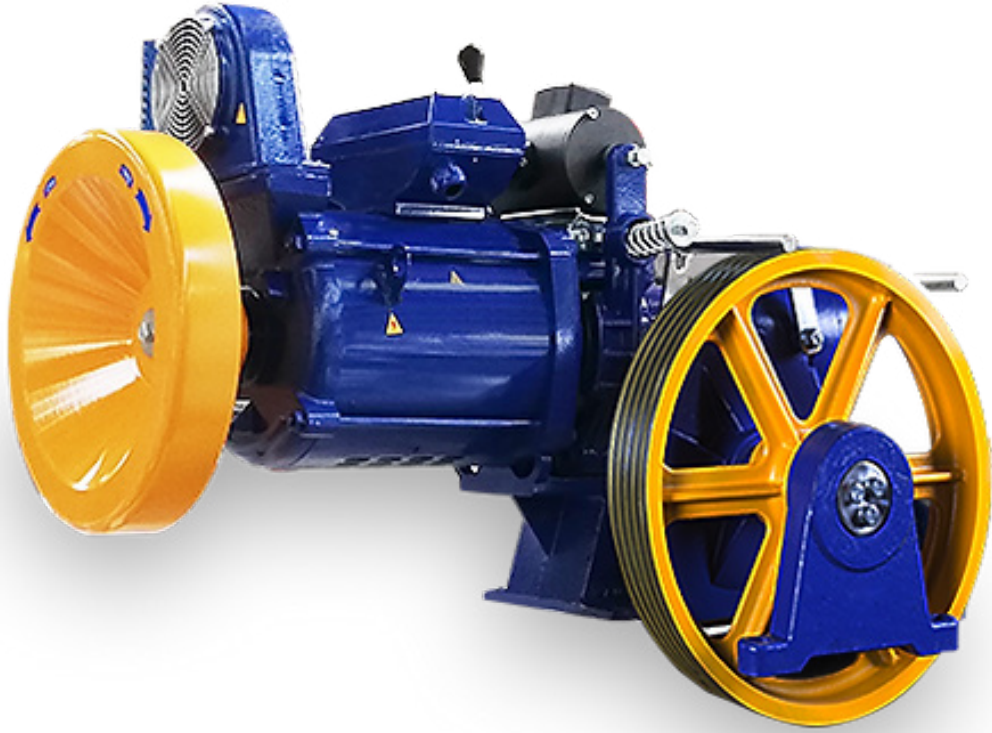

M-1-MF1 PRO E



M-2-MÜGEN MF1

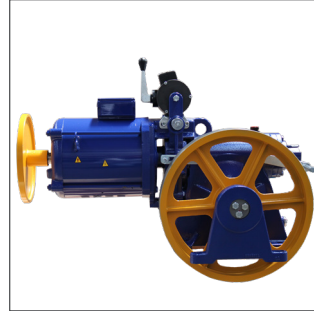

M-3-MÜGEN MF2



M-4-VOLPİ VF2



M-110 GEM-HW140C



M-71 ALEBERTO SASSİ LEO



M-9-Z 40 26M. TAMBURLU



M-11-ZF 82 YAN YATAKLI



M-100 TOP GEAR-ITG 134



M-81 SICOR SH140



M-92-ZIEHL ABEGG PENTA



M-62-MONTANARİ M83



M-20-MÜGEN MRL1



M-21-MÜGEN MRL2



M-22-MÜGEN MRL3



M-23-VOLPİ MRL1



M-24-VOLPİ MRL2



M-25-VOLPİ MRL3



M-26-VOLPİ MRL 4



M-32-AK4



M-40-EKER-QS1



M-41-EKER-QS3

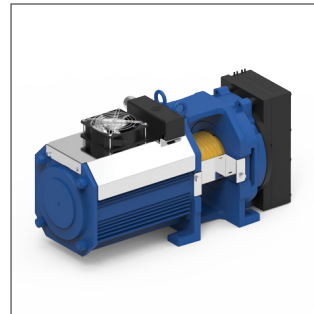

M-64-MONTANARİ MG20L

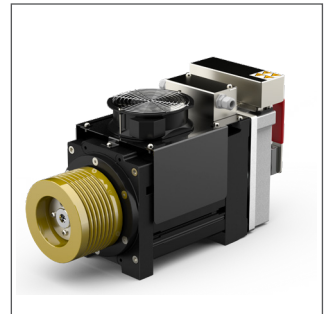

M-70-ALEBERTO SASSİ G-180

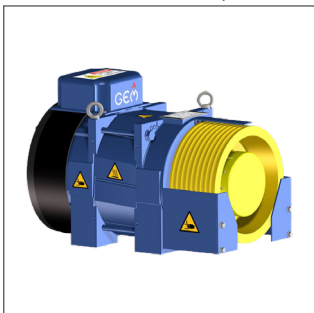

M-114 GEM GLS20



M-101 TOPGEAR-ITG05

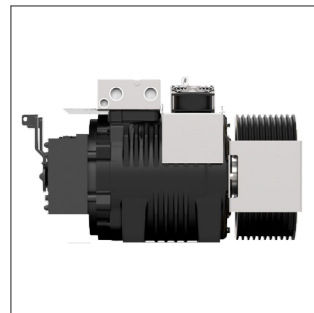

M-80-SICOR-SG22



M-93-ZIEHL-ABEGG-SM160

HAZIR TESİSAT KUMANDA PANOSU VE EKİPMANLARI
PLUG & PLAY PRE-WIRED CONTROL PANEL AND EQUIPMENT

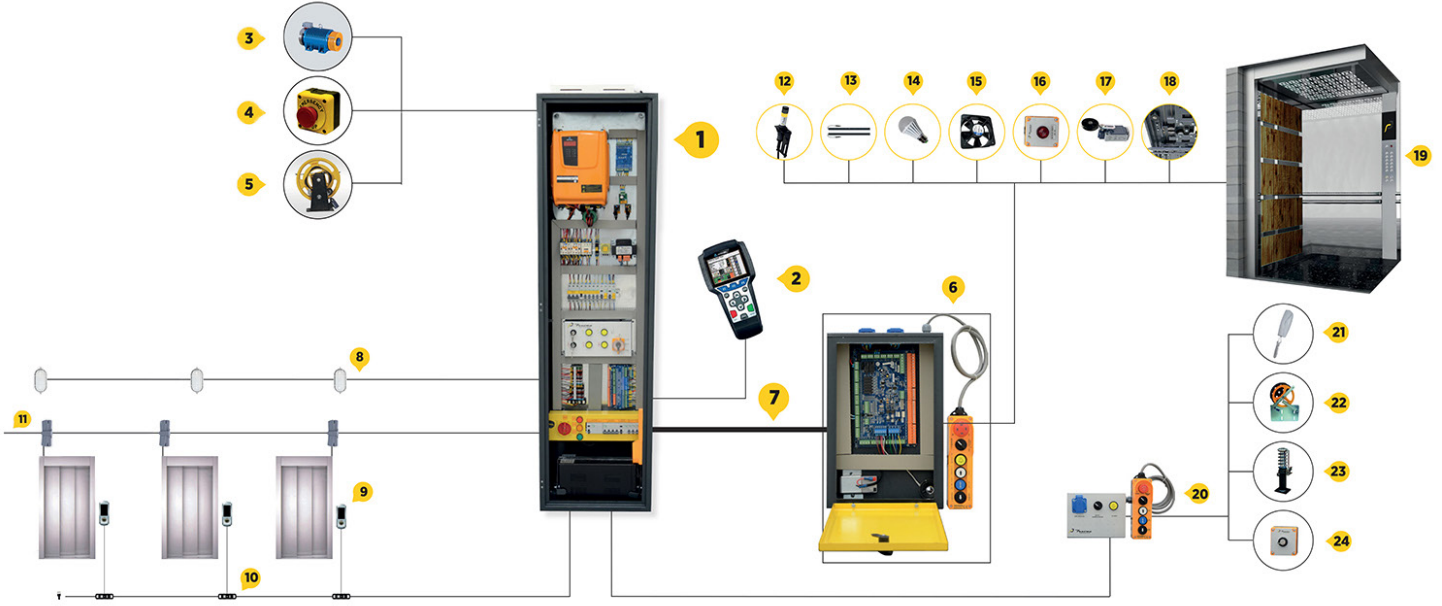

HAZIR TESİSAT KUMANDA PANOSU VE EKİPMANLARI

- 1-Asansör Kumanda Panosu
- 2-El Terminali AREM
- 3-Asansör Motoru Kumanda Panosu Arası Tüm Kablo Tesiatsı
- 4-Acil Stop Butonu
- 5-Hız Regülatörü Kumanda Panosu Arası Tüm Kablo Tesiatsı
- 6-Revizyon Panosu
- 7-Flexible Kablo Kumanda ve Revizyon Panosu Arası
- 8-Aydınlatma Armatürü Kumanda Panosu Arası Kablo Tesiatsı
- 9-Kat Butonu Bağlantı Modülü Arası Kablo Tesiatsı
- 10-Kat Butonu Bağlantı Modülü
- 11-Kat Kapısı Bağlantı Konnektörü
- 12-Kat Algılayıcı Sensör ve Sınır Şarteli Revizyon Panosu Arası Kablo Tesiatsı
- 13-Boy Fotosel
- 14-Kabin Lambası
- 15-Kabin Fanı
- 16-Kabin Altı Bypass Siren
- 17-Makaralı Sınır Şarteli
- 18-İç Kapı Komut ve Güvenlik Devresi
- 19-Kabin Butonu
- 20-Kuyu Dibi Panosu Kumanda Panosu Arası Kablo Tesiatsı
- 21-İntercom Telefon Kuyu Dibi Panosu Arası Kablo Tesiatsı
- 22-Regülatör Halat Gergi Kontakı
- 23-Kabin ve Karşı Ağırlık Kontakı
- 24-Kuyu Dibi Reset Anahtarı

PLUG & PLAY PRE-WIRED CONTROL PANEL AND EQUIPMENT

- 1-Lift Control Panel
- 2-AREM Hand Terminal
- 3-Wiring Between Machine Motor And Control Panel
- 4-Emergency Stop Button
- 5-Wiring Between Speed Governor And Control Panel
- 6-Cabin Inspection Box
- 7-Flexible Cable Between Control and Cabin Inspection Box
- 8-Wiring Between Lighting Armatures and Control Panel
- 9-Wiring Between LOP Connection Modules
- 10-LOP Connection Module
- 11-Landing Door Connector
- 12-Wiring Between Floor Sensor and Boundary Switch Cabin Inspection Box
- 13-Light Curtain
- 14-Elevator Cabin Lightning
- 15-Cabin Fan
- 16-Bypass Siren Under Cabin
- 17-Roller Switch
- 18-Cabin Door Command and Safety Circuit
- 19-COP
- 20-Wiring Between Pit Inspection Box and Control Panel
- 21-Wiring Between Intercom Phone and Pit Inspection Box
- 22-Speed Governor Rope Tensioner Ignition
- 23-Cabin and Counterweight Ignition
- 24-Pit bottom Reset Switch



P-66 Elektrik Panosu
Electric Panel

AE-127 Kuru Akü
Dry Battery

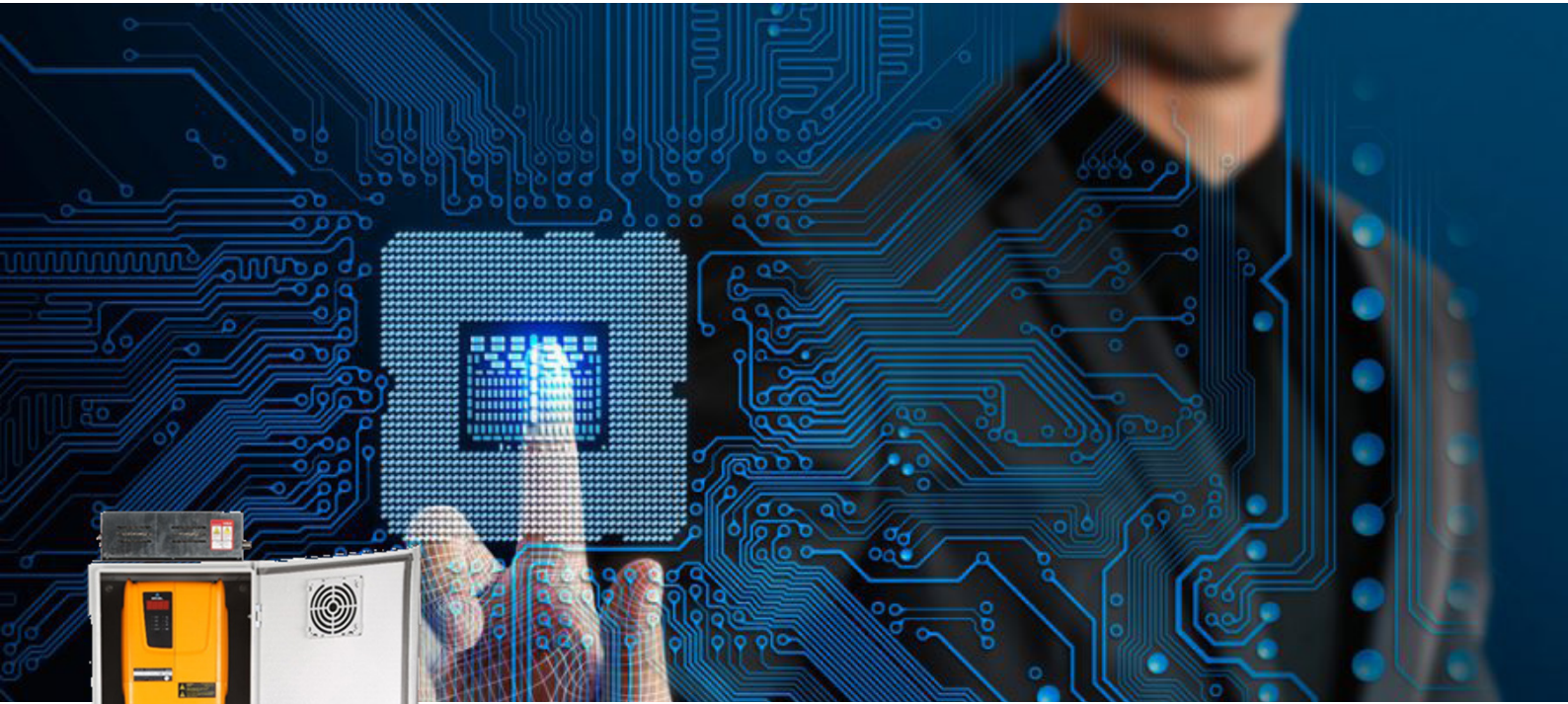

P-1 ARCODE

Dışısız Pano
Gearless Control Panel

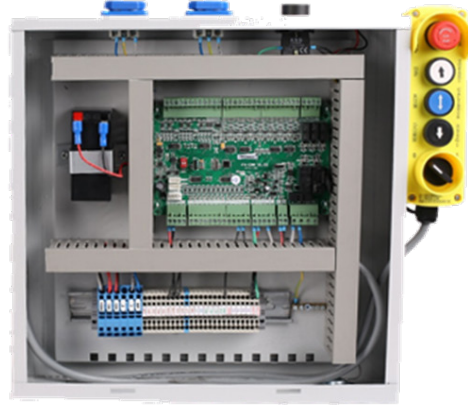

Dışılı Pano
Geared Control Panel



P-4 ARL 300

Asansör Kumanda Panosu
Geared Control Panel

P-2 ARCCUBE



Asansör Kumanda Kartları
Elevator Control Cards



P-67 Arl 100

P-68 Arl 200

P-69 Arl 300



P-70 Arl 500

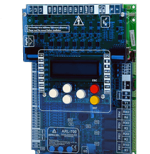

P-71 Arl 700



P-7 G&Z

ASANSÖR SÜRÜCÜLERİ ELEVATOR DRIVERS



P-320 Erşen



P-AS380 Erşen



P-81 Arcod Arkel



P-77 Arkel



P-11-HD DRIVER Hedefsan



P-12-HD DRIVER S Hedefsan



P-30 YASKAWA L1000A



P-32 Konel Rev0



P-59
UPS Güç Kaynakları
UPS Power Supplies

P-3 ARL 700



AE-151
UPS Güç Kaynakları
UPS Power Supplies

VVVF HIZ KONTROL KUMANDA PANOSU
VVVF SPEED CONTROLLED CONTROL PANEL



P-19 HEDEFSAN HD BE

P-19 HEDEFSAN HD ONE XS





ÖZELLİKLER

- 1,2 mm DKP sac üstüne 0,8 mm paslanmaz giydirme paneller
- Ses ve titreşime karşı desteklenmiştir.
- Uluslararası standartlara uygun imal edilmektedir.
- Engel tanıma özellikli kart
- Elektronik 24V trafo
- Fotosel ve yangın ikaz girişleri
- 24V fırçasız motor
- Düşük hızda yüksek tork
- Yüksek hızda yüksek konfor
- İsteğe bağlı amyant döşeme paneller

PROPERTIES

- 0,8mm stainless panles on 1,2mm DKP sheets
- Supported structure against vibration and noise
- Made according to international standards.
- Control card recognising obstacle
- Electronic 24V power supply
- Photozell and fire alarm inputs
- 24V brushless motor
- Low speed high torque
- High comfort at high speed
- Optional fire resistant flooring panels



M-2P Teleskopik Kapı
Central Door



T-2P Teleskopik Kapı
Teleskopik Door



MC-2P Cam Panel Kapı
Glassed Panel Door



T-2P Satine Paslanmaz Teleskopik Kat Kapısı
Satin Stainless Steel Telescopic Floor Door

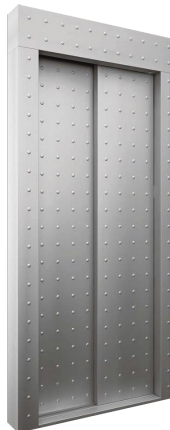

TB-2P Satine Paslanmaz Baskılı Teleskopik Kat Kapısı
Satin Stainless Steel Printed Telescopic Floor Door



TDS-2P Dekoratif Paslanmaz Merkezi Kat Kapısı
Decorative Satin Stainless Steel Central Floor Door



TG-2P Altın Teleskopik Kat Kapısı
Gold Telescopic Floor Door



TS-2P Gümüş Teleskopik Kat Kapısı
Silver Telescopic Floor Door



TC-2P Bakır Teleskopik Kat Kapısı
Copper Telescopic Floor Door



TSAD-2P Gümüş Ayna Dekoratif
Teleskopik Kat Kapısı
Silver Mirror Decorative Telescopic
Floor Door



MGA-2P Altın Ayna Teleskopik Kat Kapısı
Gold Mirror Telescopic Floor Door



MSA-2P Gümüş Ayna Teleskopik Kat Kapısı
Silver Mirror Telescopic Floor Door



TCA-2P Bakır Ayna Teleskopik Kat Kapısı
Copper Mirror Telescopic Floor Door

KRAMER KATLANIR KAPILAR - KRAMER FOLDING DOOR



DTKK- D Tipi Kramer Katlanır Ön Kapı
D Type Kramer Folding Front Door



DTKK- D Tipi Kramer Katlanır Arka Kapı
D Type Kramer Folding Back Door



WTKK- W Tipi Kramer Katlanır Ön Kapı
W Type Kramer Folding Front Door



WTKK- W Tipi Kramer Katlanır Arka Kapı
W Type Kramer Folding Back Door



CK-02



CK-03



CK-04

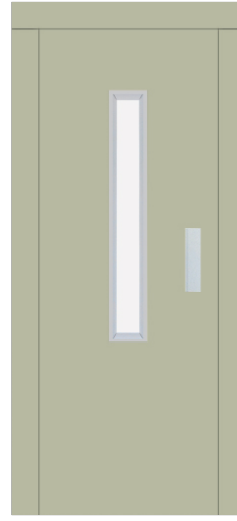

CK-06



CK-07



CK-08



CK-09

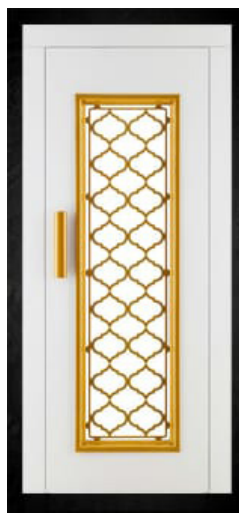

CK-11

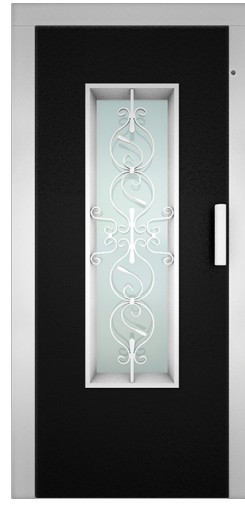

CK-14



CK-15

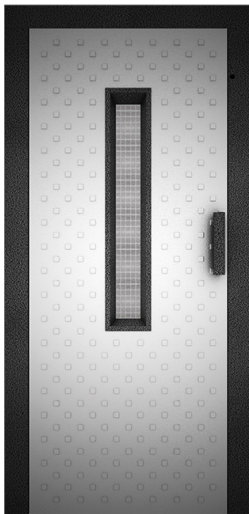

CK-16

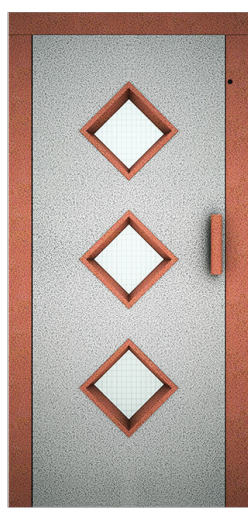

CK-17

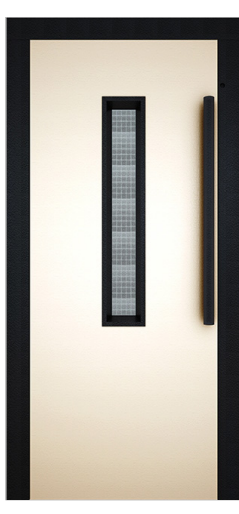

CK-18



CK-20



CK-22



ASANSÖR KLAVUZ RAYLARI
ELEVATOR GUIDE RAILS



RK-3-6X8



RK-4-6X12



RK-5-6X15



RK-6-6X18



RK-8-6X20



RK-11-6X10



RK-14-6X12



RK-15-6X6



RK-16



RK-19-5X7



RK-25-6X4

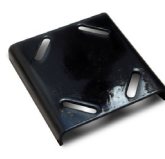

RK-26



RK-28



RK-29



RK-32

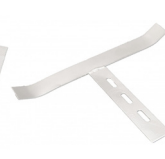

RK-42

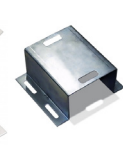

RK-41



RK-17



RK-33



RK-34



RK-35



RK-40

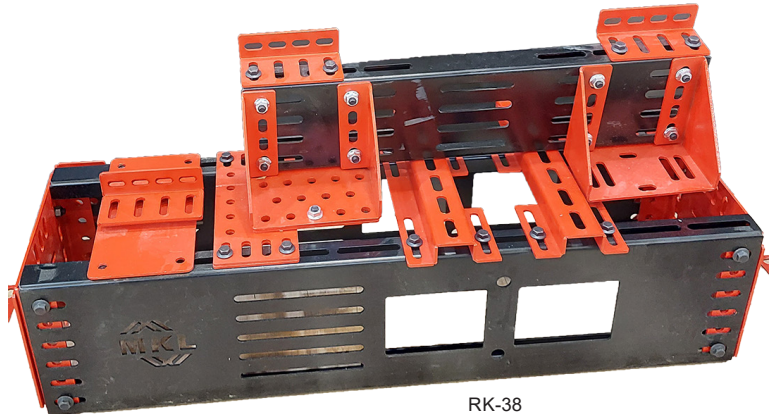

RK-38



S-1 Dişlili Ağırlık Şasesi
Center Weight Chassis Geared

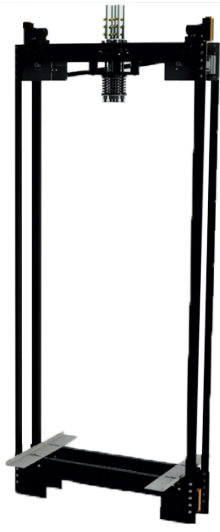

S-2 Dişlili Süspansiyon
Car Sling Geared



S-3 Dişlisiz Ağırlık Şasesi
Center Weight Chassis Gearless



S-4 Dişlisiz Süspansiyon
Car Sling Gearless



S-5 LK Karkas
Elevator Frame



S-6 Kuyu Dipsiz L Karkas
L Frame With Out Pit

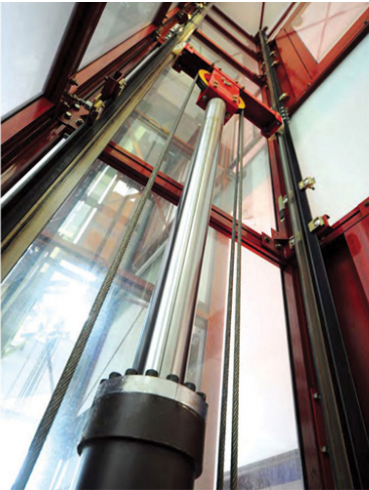

S-7 Hidrolik L Karkas
L Frame For Hydraulic Lift



S-8 LK Karkas Direk Askı
L Carcass - Direct Suspension



S-9 Hidrolik L Karkas
L Frame For Hydraulic Lift

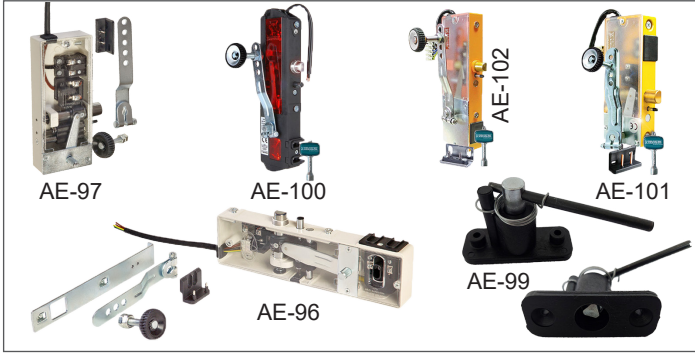

Kapı Kilitleri
Door Locks

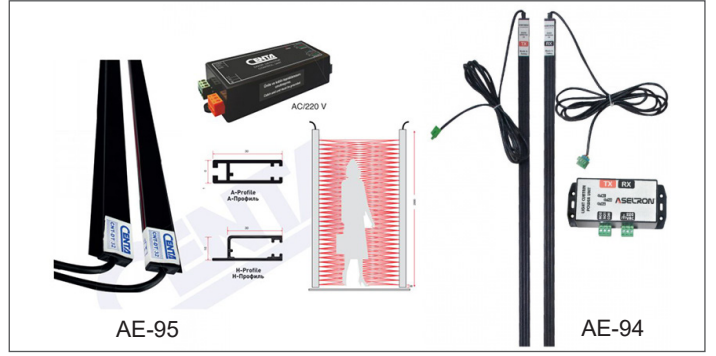

Fotoseller
Photocells

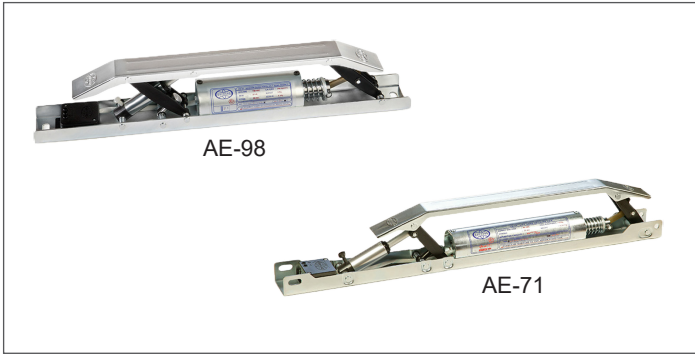

Kat Kapısı Kilit Açma Magneti Pompa
Landing Door Unlocking Magnet Pump

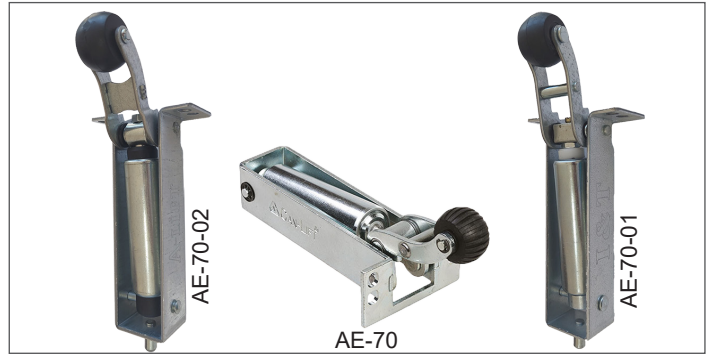

Asansör Kapı Amortisörü
Door Shock Absorber

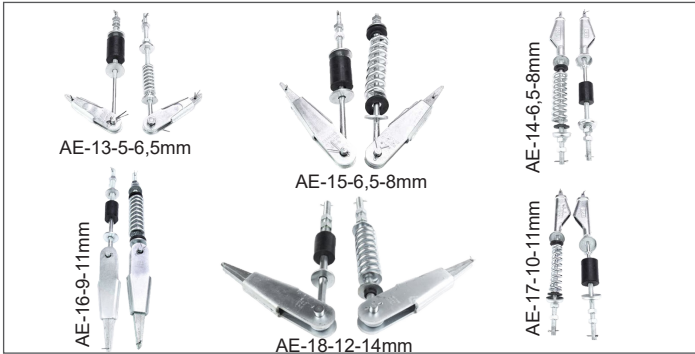

Oynar Başlıklı ve Sabit Halat Şişeleri
Swinging-Fixed Rope Attachment



Plastik ve Poliüretan Tampon
Plastic and Polyurethane Buffer

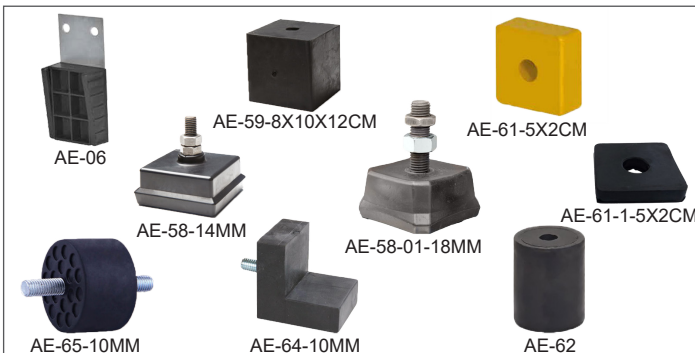

Makine Takozları
Machine Wedges



Hidrolik Tamponlar
Hydraulic Buffers



Sac Tırnak Halat Klemensi
Sheet Metal Clip Rail Clip Rope Clamp

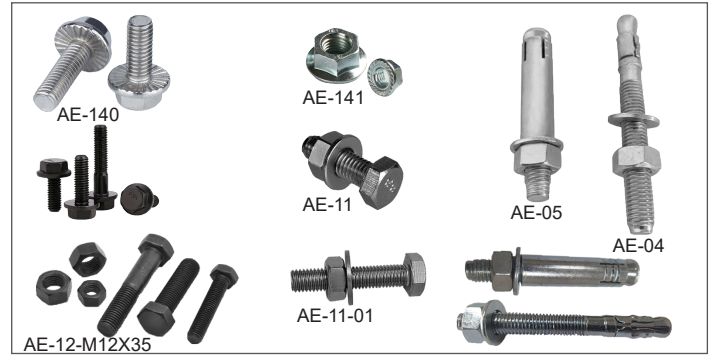

Flanşlı Somun Civata Dubel
Flanged Nut Bolt Pipe Steel Dowel

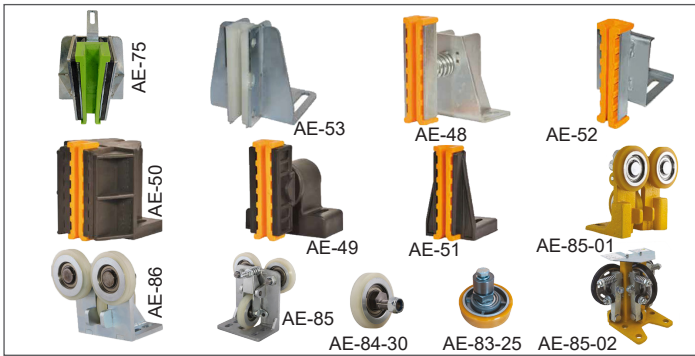

Sac-Plastik Ağırlık ve Kabin Patenleri
Sheet-Plastic Weight and Cabin Skates



Plastik-Slikon-Poliüretan Asansör Paten Ağızları
Plastic-Silicon-Polyurethane Elevator Skates



Denge Zinciri Makarası ve Sacı
Compensation Chain Roller And Sheet



Kablo Kanalı Spiral Boru Mono Stabil BiStabil Kuyu Aydınlatma
Cable Trunking Spiral Hose Mono Stabil BiStabil Shaft Lighting



El Terminalleri Sigorta Fan Frenleme Direnci Acil Butonu
Hand Terminals Fuse Fan Braking Resistor Emergency Button

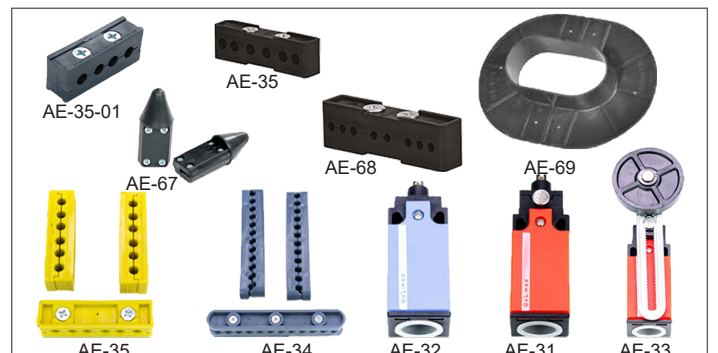

Halat Sıralayıcısı Makaralı Switch
Rope Holder Roller Switch



Flexible DT13 NYAF NYA Kabloları
Flexible DT13 NYAF NYA Cables

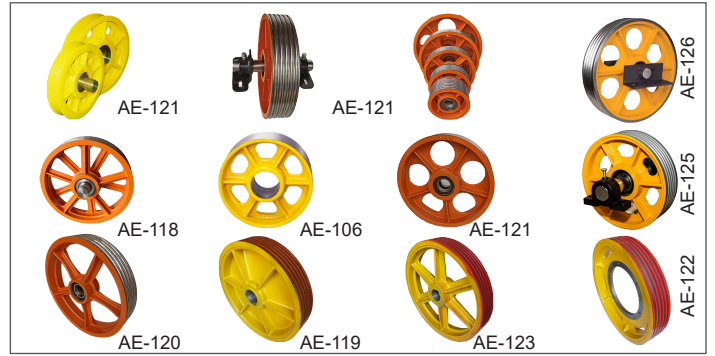

Saptırma Palanga Hidrolik Tahrik Kasnakları
Diversion Suspension Pulley Hydraulic Driving Pulleys



Ayarlanabilir Ahtapot Tipi Kuyu Arabölme Set-1
U Brackets Adjustable Shaft Divider Octopus Type Set-1

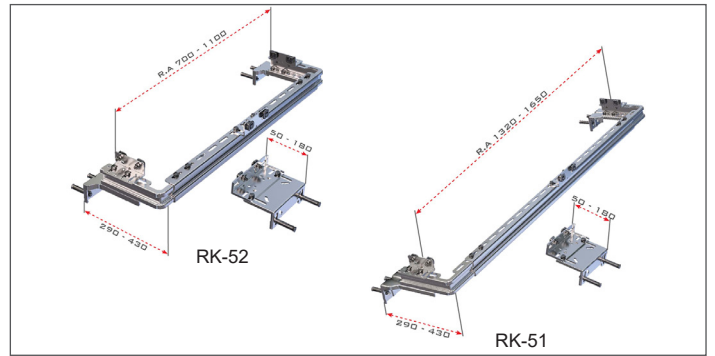

Ayarlanabilir Ahtapot Tipi Kuyu Arabölme Set-2
U Brackets Adjustable Shaft Divider Octopus Type Set-2

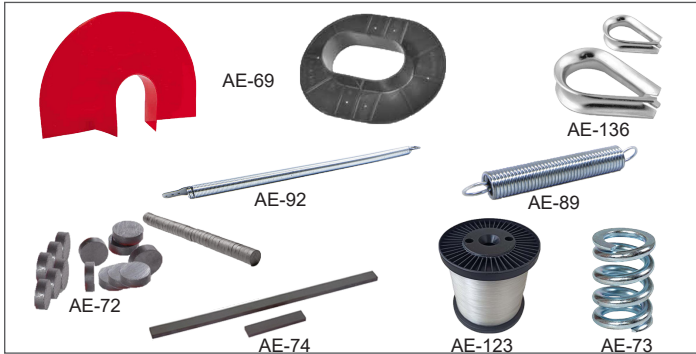

Radansa Mıknatıs Misina Halat Şapkası Kapı ve Aşırı YükYayları
Radansa Magnet Fishing Line Rope Cover Door Overload Springs

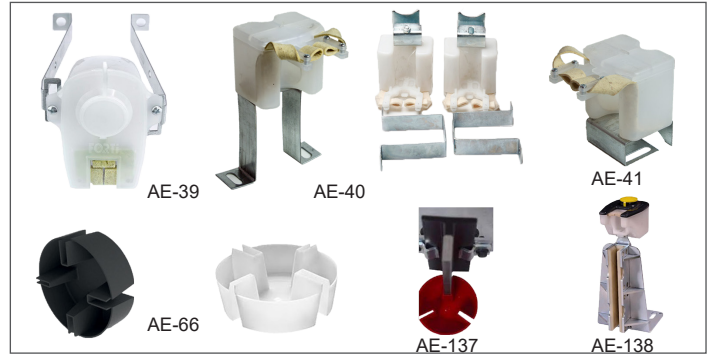

Yağdanlık Yağ Yoplama Kabı
Lubricator Oil Collection Cup

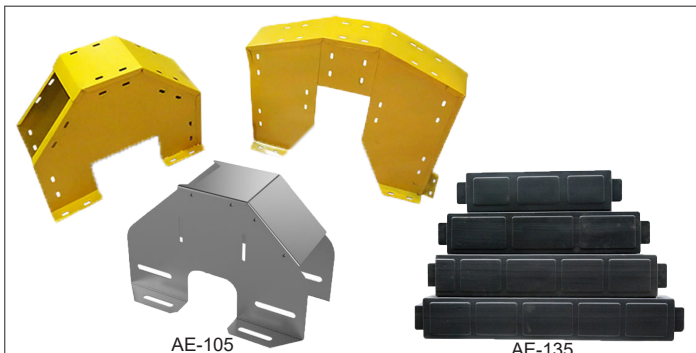

Kasnak Muhafaza Takımı ve Baritler
Sheave Protection Cover and Counterweight Filling

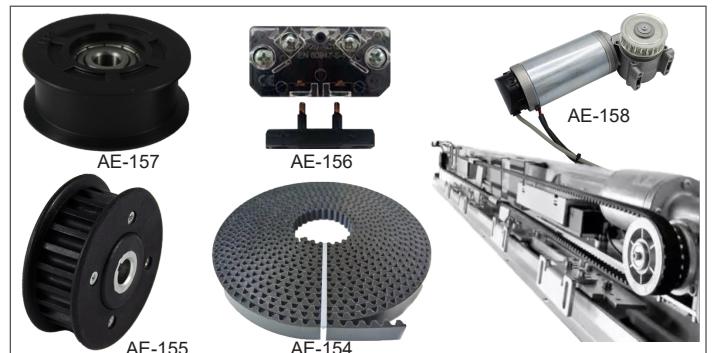

Gerdirme Kasnağı Fiş Kontakt Motor ve Dişlisi Kayış
Pulley Door Contactor Motor and Engine Gear Strap

ÇİFT YÖNLÜ KAYMA EMNİYET TERTİBATI - BI-DIRECTIONAL PROGRESSIVE SAFETY GEAR

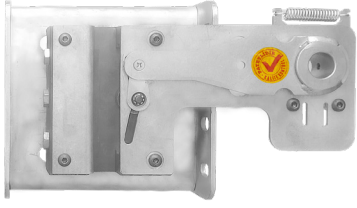

MK01 S STANDART KAYMA FREN
STANDARD SLIP BRAKE

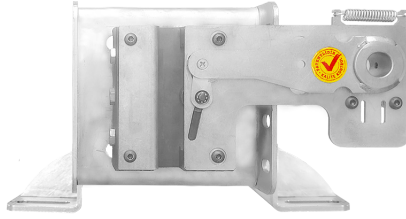

MK01 R REVİZYON FREN
REVISION BRAKE



MK01 L KARKAS FREN
L CARCASS BRAKE

ÜRÜN/ PRODUCT	RAY/RAIL	MAX BEYAN HIZI/ MAX CABIN SPEED	(P+Q) KAPASİTE/ CAPACITY
MK01 SERİ	8-9-10 MM	1,60 M/S	700 - 1400 KG
MK02 SERİ	16 MM	1,60 M/S	700 - 3000 KG

1,00 M/SN İLE 1,60 M/SN ARASINDA HIZA SAHİP ASANSÖRLERDE KULLANIMA UYGUNDUR. IT IS SUITABLE FOR USE IN ELEVATORS WITH SPEED BETWEEN 1.00 M/Sec and 1.60 M/Sec.

EMNİYET TERTİBATI-ÖZELLİKLER

- Ters Yön Hareket Sistemi
- Hareketli fren laması sayesinde;
- Fren den kolay kurtulmayı sağlar
- Yumuşak frenleme sağlar
- Kolay Montaj
- Geniş süspansiyon slotları
- NPU'suz direk bağlantı
- Hassas ayar avantajı

SAFETY GEAR-PROPERTIES

- Reverse Direction Movement System:
- Provides easy brake pad detachment
- And soft braking thanks to moving
- Cast iron brake pads
- Simple Gear
- Wide suspension slots
- Direct connection without NPU
- Advantage of delicate adjustment

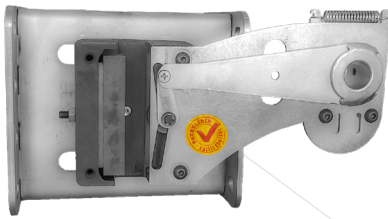

MKL E SERİSİ KAYMA FREN
STANDARD SLIP BRAKE

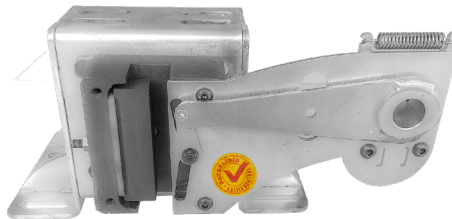

MKL E SERİSİ
REVİZYON FREN
REVISION BRAKE

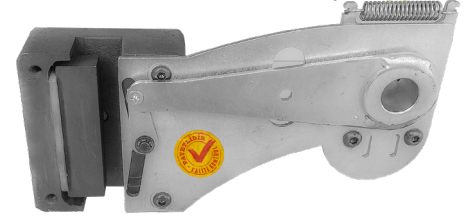

MKL E SERİSİ
L KARKAS FREN
L CARCASS BRAKE

Her bir kayma fren gurubumuzda 70'lik ve 90'lık modellerimiz mevcuttur. Ürün hız ve kapasite değerleri tabloda belirtilmiştir.

70' and 90' safety gears are available among each product group. Speed and capacity datas are presented below:

ÜRÜN/ PRODUCT	RAY/RAIL	MAX.BEYAN HIZI / MAX CABIN SPEED	(P+Q) KAPASİTE/ CAPACITY
E 70 SERİ	8-9-10 MM	1,00 M/S	700 - 1750 KG
E 90 SERİ	16 MM	1,00 M/S	700 - 3000 KG

HIZI 1,00 M/SN ALTINDA ÇALIŞAN ASANSÖRLERDE KULLANIMA UYGUNDUR. SUITABLE FOR USE IN ELEVATORS WITH CABIN SPEED NOT MORE THAN 1.00 M/SEC

PATENTLİ ÜRÜN: Kayma fren sistemlerimizde Türkiye'de bir ilk olarak uygulanan düz frenleme pabucunda hareket mekanizması bulunmaktadır. Yumuşak frenleme ve temassız fren den kurtulmayı amaçlayan sistemimizle bir ilki daha gerçekleştirerek Dünyada ilk kez yaylı esneme sistemini başarıyla gerçekleştirmiş olmanın gururunu yaşıyoruz.

PATENT ARTICLE: Flat brake pads are created with an action mechanism in our progressive safety gear system.

We are proud of achieving springy elaxion system, providing a soft breaking and brake pad detactment, a first in Turkey and in the world.

HIZ REGÜLATÖRLERİ - OVERSPEED GOVERNORS



MKL-MD

MAKİNA DAİRESİZ REGÜLATÖR
SPEED GOVERNORS - MACHINE ROOMLESS

- Güçlendirilmiş bobin sistemi
- Statik toz boya
- Döküm alt gergi kasnağı
- Yaylı alt gergi sistemi

- Reinforced bobbin system
- Static powder paint
- Lower tension pulley-Casting
- Spring-loaded lower tension system



MKL-A3

A3 BOBİNLİ REGÜLATÖR
SPEED GOVERNORS - A3 BOBBIN

HIZ REGÜLATÖR ÖZELLİKLERİ

- UCM için ön tetikleme bobini
- 320 mm kasnak
- Min. 0,63 m/sn Max. 2,50 m/sn
- Montaj kolaylığı

OVERSPEED GOVERNORS PROPERTIES

- With pre triggering coil for UCM
- 320 mm pulley
- Min. 0.63 m/s Max 2.50 m/s
- Ease of installation



MKL-CH

ÇİFT HIZ REGÜLATÖR
SPEED GOVERNORS - DOUBLE SPEED

- Çift yönlü geniş hız aralığı
- Plastik alt gergi kasnağı
- Sessiz çalışma
- Güçlü gövde

- Bi-directional wide speed range
- Plastic Tension Pulley
- Silent operation
- Strong frame

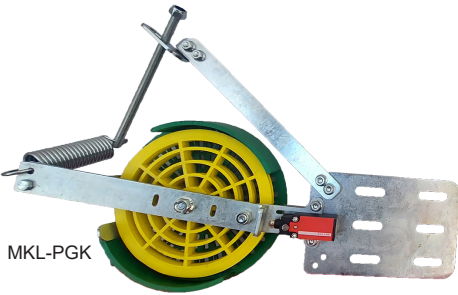

MKL-PGK

PLASTİK ALT GERĞİ KASNAĞI
PLASTIC TENSION PULLEY



MAKİNA DAİRESİZ REGÜLATÖR
SPEED GOVERNORS - MACHINE ROOMLESS

ÇİFT HIZ REGÜLATÖRLER A3 BOBİNLİ REGÜLATÖRLER MAKİNA DAİRESİZ REGÜLATÖRLER

-Regülatörlerimiz TS- EN 81-20 ve TS- EN 81-50 yönetmeliklerine uygun olarak üretilmektedir.

-Her bir regülatör ürün grubumuzda da Min. 0,63 m/sn hızından Max. 2,50 m/sn hızına kadar ürün modellemelerimiz mevcuttur.

-Regülatörlerimizin alt gergi kasnakları yaylı sistemle üretilmekte olup, müşterilerimizin kolay montaj yapabilmelerine olanak sağlayacak şekilde dizayn edilmiştir.

SPEED GOVERNORS - DOUBLE SPEED SPEED GOVERNORS - A3 BOBBIN SPEED GOVERNORS - MACHINE ROOMLESS

-Our speed governors are produced in accordance with the lift directive EN 81:20 and EN 81:50.

-All speed governors are adjustable between 0,63 and 2,50 m/s speed.

-Tension pulleys are produced with springs so that the installation can be completed easily.

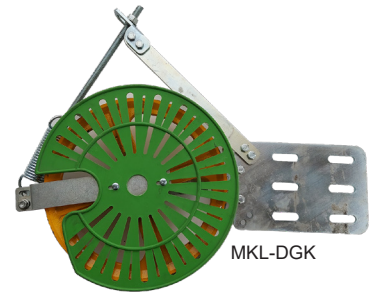

MKL-DGK

DÖKÜM ALT GERĞİ KASNAĞI
CASTING TENSION PULLEY



PK-1 Oval Panoramik Kabin
Round Panoramic Cabin



PK-2 Kare Panoramik Kabin
Square Panoramic Cabin



ÖZELLİKLER

- 1,5 mm sac kabin duvarları
- 304 kalite paslanmaz çelik
- Hem iç hem dış paslanmaz kaplama
- Tamamı lazer kesimli parçalar
- Kolay montaj edilebilir yapı
- Extra mukavemet için teknik bükümler
- Farklı taban ve tavan seçenekleri
- Talep doğrultusunda yapılan özel uygulamalar

PROPERTIES

- 1,5 mm sheet metal cabin wall
- 304 quality stainless steel
- Both internal and external stainless coating
- All parts are laser cut
- Easy assembly structure
- Technical bends for extra strength
- Different floor and ceiling options



OA-06

SH-1 Sedye Kabini
Hospital Cabin



YA-1 Yük Kabini
Freight Cabin



ÖZELLİKLER

- 1,5 mm sac kabin duvarları
- ESB boya seçenekleri
- Paslanmaz kaplama seçenekleri
- Çarpma yumuşatıcı kuşaklar
- Tamamı lazer kesimli parçalar
- Kolay montaj edilebilir yapı
- Extra mukavemet için teknik bükümler
- Farklı taban ve tavan seçenekleri
- Talep doğrultusunda yapılan özel uygulamalar

PROPERTIES

- 1,5 mm sheet metal cabin wall
- ESB raf paint options
- Stainless coating options
- Impact softening band
- All parts are laser cut
- Easy assembly structure
- Technical bends for extra strength
- Different floor and ceiling options
- Special applications made on request

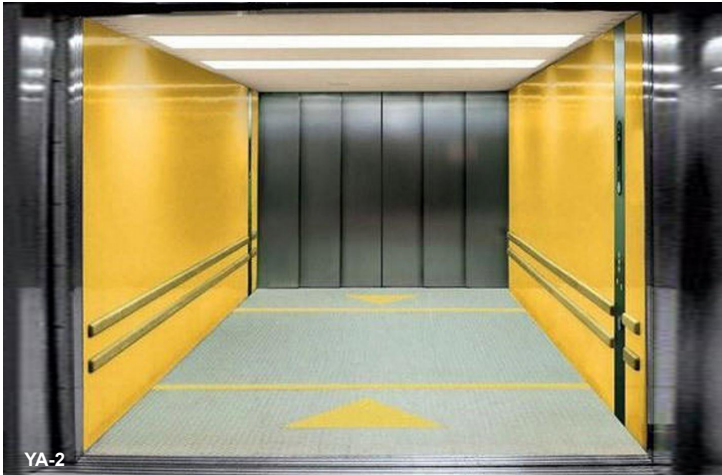





MSA-3



MSA-8



MSA-9



MSA-2



MSA-1



MSA-4



MSA-7



MSA-5

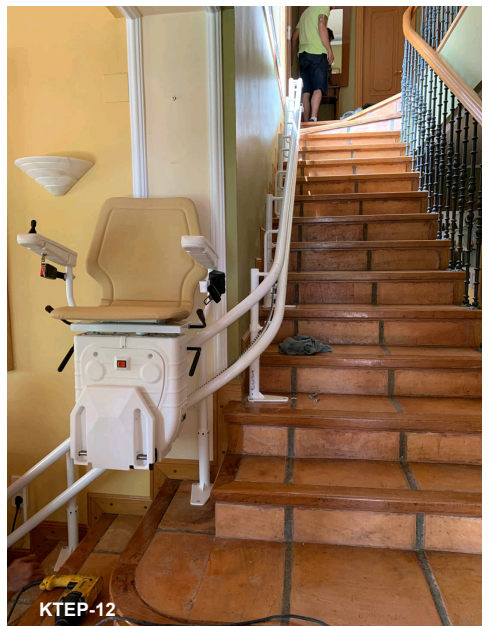

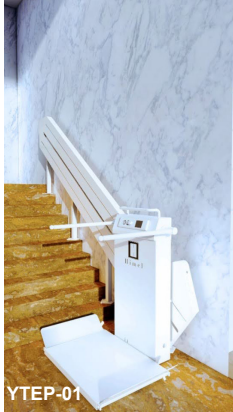
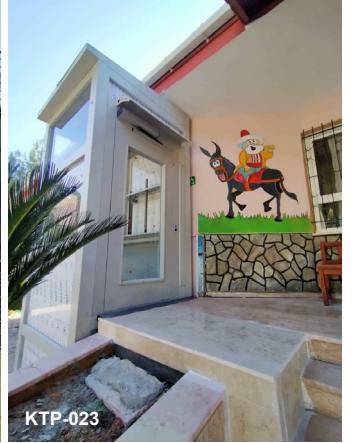

İnsan Asansörleri (Sınıf I-II) Fonksiyonel Boyutlar/ Passenger Elevators (Class I-II) Functional Dimensions															
				KONUTLAR / HOUSES				İŞYERLERİ / OFFICES							
TAŞIMA KAPASİTESİ / CAPACITY			(Kg)	320	400	630	1000	630	800	1000	1250	1600			
ANMA YÜKÜ / NOMINAL LOAD			(Kişi)	4	5	8	13	8	10	13	16	21			
KABİN ALANI / CABINSPACE			(min)	0,79	0,98	1,45	2,15	1,45	1,73	2,15	2,57	3,245			
			(max)	0,95	1,17	1,66	2,40	1,66	2,00	2,40	2,90	3,56			
KABİN EBATLARI CABIN DIMENSIONS		Genişlik / Width	b1	(mm)	900	1100	1100	1100	1100	1350	1600	1950			
		Derinlik / Depth	d1	(mm)	1000	1000	1400	2100	1400	1400	1400	1400	1750		
		Yükseklik/Height		(mm)	2200	2200	2200	2200	2200	2200	2300	2300	2300		
DURAK KAPILARI LANDING DOORS		Genişlik	b2	(mm)	700	800	800	800	800	800	1100	1100			
		Yükseklik	h3	(mm)	2000	2000	2000	2000	2000	2000	2100	2100			
KUYU EBATLARI SHAFT DIMENSIONS		Genişlik 1	b3	(mm)	1400	1600	1600	1600							
		Genişlik 2	b3	(mm)		1800	1800	1800	1800	1900	2400	2600			
		Derinlik	d2	(mm)	1600	1600	1900	2600	2100	2300	2300	2300			
KUYU DİBİ DERİNLİĞİ PIT		0,63m/sn	d3	(mm)	1400	1400	1400	1400	1400	1400	1400	1600			
		1,00m/sn	d3	(mm)	1400	1400	1400	1400	1400	1400	1400	1600			
		1,60m/sn	d3	(mm)		1600	1600	1600	1600	1600	1600	1600			
		2,50m/sn	d3	(mm)			2200	2200		2200	2200	2200			
EN ÜST DURAK SEVİYESİ ÜS- TÜNDEKİ YÜKSEKLİK OVERHEAD		0,63m/sn	h1	(mm)	3600	3600	3600	3600	3800	3800	4200	4400			
		1,00m/sn	h1	(mm)	3700	3700	3700	3700	3800	3800	4200	4400			
		1,60m/sn	h1	(mm)	3800	3800	3800	3800	4000	4000	4200	4400			
		2,50m/sn	h1	(mm)			5000	5000		5000	5200	5400			
MAKİNA DAİRESİ MACHINE ROOM		ALAN SPACE		0,63m/sn	A	(m2)	6	7,5	10	12	15	15	20	22	25
				1,00m/sn	A	(m2)	6	7,5	10	12	15	15	20	22	25
				1,60m/sn	A	(m2)		10	12	14	15	15	20	22	25
				2,50m/sn	A	(m2)			14	16		18	20	22	25
		GENİŞLİK WIDTH		0,63m/sn	h1	(mm)	1600	2200	2200	2400	2500	2500	3200	3200	3200
				1,00m/sn	h1	(mm)	1600	2200	2200	2400	2500	2500	3200	3200	3200
				1,60m/sn	h1	(mm)		2200	2200	2400	2500	2500	3200	3200	3200
				2,50m/sn	h1	(mm)			2800	2800		2800	3200	3200	3200
		DERİNLİK DEPTH		0,63m/sn	d4	(mm)	3000	3200	3700	4200	3700	3700	4900	4900	5500
				1,00m/sn	d4	(mm)	3000	3200	3700	4200	3700	3700	4900	4900	5500
				1,60m/sn	d4	(mm)		3200	3700	4200	3700	3700	4900	4900	5500
				2,50m/sn	d4	(mm)			3700	4200		3700	4900	4900	5500
		YÜKSEKLİK HEIGHT		0,63m/sn	h2	(mm)	2000	2000	2000	2000	2200	2200	2400	2400	2800
				1,00m/sn	h2	(mm)	2000	2000	2000	2000	2200	2200	2400	2400	2800
				1,60m/sn	h2	(mm)		2200	2200	2200	2200	2200	2400	2400	2800
				2,50m/sn	h2	(mm)			2600	2600		2800	2800	2800	2800

*Sağa veya sola toplanan teleskopik kapılı asansörler için / For telescopic elevators with doors opening to the right and left

**Merkezden açılan kapılı asansörler için / For elevators with central opening

***320 ve 400Kg taşıma kapasiteli asansörler engelli kişilerin tekerlekli sandalyede asansörü kullanmaları için uygun değildir / Elevators with a load capacity of 320 and 420 kg are not suitable for use by people with disabilities in a wheelchair

Hasta Asansörleri (Sınıf I-II) Fonksiyonel Boyutlar/ Patient Lifts (class I-II) Functional Dimensions							
TAŞIMA KAPASİTESİ/ Capacity			(Kg)	1600	2000	2500	
KABİN ALANI / Cabin Space			(min)	3,245	3,82	4,625	
			(max)	3,56	4,2	5	
KABİN EBATLARI Cabinet Dimensions	Genişlik / Width	b1	(mm)	1400	1500	1800	
	Derinlik / Depth	d1	(mm)	2400	2700	2700	
	Yükseklik / Height		(mm)	2300	2300	2300	
DURAK KAPILARI Stall Doors	Genişlik / Width	b2	(mm)	1300	1300	1300	
	Yükseklik / Height	h3	(mm)	2100	2100	2100	
KUYU EBATLARI Pit Dimensions	Genişlik / Width	b3	(mm)	2400	2400	2700	
	Derinlik/ Depth	d2	(mm)	3000	3200	3300	
KUYU DİBİ DERİNLİĞİ Elevator Pit Bottom	Vn=0,63m/sn	d3	(mm)	1600	1600	1800	
	Vn=1,00m/sn	d3	(mm)	1700	1700	1900	
	Vn=1,60m/sn	d3	(mm)	1900	1900	2100	
	Vn=2,50m/sn	d3	(mm)	2500	2500	2500	
EN ÜST DURAK SEVİYESİ ÜSTÜNDEKİ YÜKSEKLİK Height Above the Highest Stall Level	Vn=0,63m/sn	h1	(mm)	4400	4400	4400	
	Vn=1,00m/sn	h1	(mm)	4400	4400	4600	
	Vn=1,60m/sn	h1	(mm)	4400	4400	4600	
	Vn=2,50m/sn	h1	(mm)	5400	5400	5600	
MAKİNA DAİRESİ Engine Room	ALAN / Space	A	(m ²)	25	27	29	
	GENİŞLİK / Width	b4	(mm)	3200	3200	3500	
	DERİNLİK / Depth	d4	(mm)	5500	5800	5800	
	YÜKSEKLİK / Height	h2	(mm)	2800	2800	2800	
Yük Asansörleri (Sınıf IV) Fonksiyonel Boyutlar/ Load Elevators (Class IV) Functional Dimensions							
TAŞIMA KAPASİTESİ/ Carriage Quality			(Kg)	630	1000	1600	2000
KABİN EBATLARI Cabinet Dimensions	Genişlik / Width	b1	(mm)	1100	1300	1500	1500
	Derinlik / Depth	b1	(mm)	1 400	17 50	2250	2700
	Yükseklik / Height		(mm)	2200	2300	2200	2200
DURAK KAPILARI Stall Doors	Derinlik / Depth	b2	(mm)	1100	1300	1500	1500
	Yükseklik / Height	h3	(mm)	2100	2100	2100	2100
KUYU EBATLARI Pit Dimensions	Genişlik/ Width	b3	(mm)	2100	2400	2700	2700
	Derinlik / Depth	d2	(mm)	1900	2300	2800	3200
KUYU DİBİ DERİNLİĞİ Elevator Pit Bottom	V<1,00m/sn	d3	(mm)	1500	1500	1700	1700
EN ÜST DURAKSEVİYESİ ÜSTÜNDEKİ YÜKSEKLİK Height Above the Highest Stall Level	V<1,00m/sn	h1	(mm)	4100	4100	4300	4300
MAKİNA DAİRESİ Engine Room	ALAN /Space	A	(mm)	12	14	18	20
	GENİŞLİK / Width	b4	(mm)	2800	3100	3400	3400
	DERİNLİK / Depth	d4	(mm)	3500	3800	4500	4900
	YÜKSEKLİK/ Height	h2	(mm)	2200	2200	2400	2400
Servis Asansörleri (Sınıf V) Fonksiyonel Boyutlar / Service Elevators(Class V) Functional Dimensions							
TAŞIMA KAPASİTESİ/ Carriage Quality			(Kg)	40	100	250	
KABİN EBATLARI Cabinet Dimensions	Genişlik / Width	b1	(mm)	600	800	1000	
	Derinlik / Depth	d1	(mm)	600	850	1000	
	Yükseklik / Height		(mm)	800	800	1200	
KUYU EBATLARI Pit Dimensions	Genişlik / Width	b3	(mm)	900	1100	1500	
	Derinlik / Depth	d2	(mm)	800	1000	1200	



Hayal Ettiğiniz Hayata Yükselin “Raise your imagine life”

FAALİYET GÖSTERDİĞİMİZ DİĞER ALANLAR VE ŞİRKETLERİMİZ

MARİF KALKAN DEMİR SANAYİ VE TİC. LTD. ŞTİ.

- TOPTAN Yassı Metal (SAC) (Siyah, Galvaniz, DKP, Paslanmaz vb.). HADDE Demir (NPU, NPI, iPE, Köşebent vb.) ve PROFİL satışı,
- Plazma Kesim Hizmetleri,
- Abkant Kesim ve Büküm Hizmetleri,
- Lazer Kesim Hizmetleri.

İLETİŞİM

- Adres: Büsan O.S.B. Fevzi Çakmak Mh. 10764 Sk. No:2/A Karatay/ KONYA
- Santral: +90 332 248 02 86
- Satış: +90 549 546 51 57 - +90 549 546 51 59
- Plazma Abkant: +90 507 513 62 34
- Lazer Kesim: +90 538 267 61 73
- Web: <https://kalkanmetalgrup.com>

MARİF KALKAN DIŞ TİCARET İTHALAT İHRACAT SANAYİ VE TİC.LTD.ŞTİ

- Her türlü üretilen ürün ve hizmetlerin YURT DIŞI satışı
- Web: <https://mklasansor.com>
- Mail: salesexport@mklasansor.com

İLETİŞİM

- Adres: Konsan O.S.B. Fevzi Çakmak Mh. 10728 Sk. No:4 Karatay/KONYA
- Santral: +90 332 346 54 54
- Satış (İngilizce): +90 539 336 28 13
- Satış (Fransızca): +90 531 727 65 35



/mklasansor

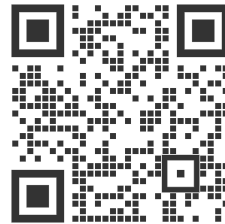



FABRİKA

MKL Asansör Oto.İnş.Nak.San.ve Tic.Ltd.Şti

Adres: Fevzi Çakmak Mh, 10728. Sk. No:4, 42050
Karatay/KONYA/TÜRKİYE

Telefon: +90 332 346 54 54

Mail: info@mklasansor.com

Teknik: uretim@mklasansor.com

Hayal Ettiginiz Hayata Yükselin
"Raise your imagine life"

www.mklasansor.com